

**REMER**  
**RUBINETTERIE**



2024  
**NEWS**



08 **CELEBRITY**



24 **METRICA**



38 **CHRONO**



54 **ATELIER**



66 **ELEMENT**



80 **SLASH&DOT**



100 MISCELATORI AD INCASSO - BUILT-IN MIXERS

# 2024 NEWS



118 SOFFIONI - SHOWER HEAD



122 SHUT-OFF



128 ACQUA DEPURATA - PURIFIED WATER





**CR** CROMO  
*CHROME*



**BO** BIANCO OPACO  
*MATT WHITE*  
FIN 1



**NO** NERO OPACO  
*MATT BLACK*  
FIN 1



**DO** ORO LUCIDO  
*SHINY GOLD*  
FIN 2



**XV** VISUAL INOX  
*VISUAL STEEL*  
FIN 1



**BG** ORO SPAZZOLATO  
*BRUSHED GOLD*  
FIN 2



**NP** NICHEL SPAZZOLATO  
*BRUSHED NICKEL*  
FIN 1



**RP** RAME SPAZZOLATO  
*BRUSHED COPPER*  
FIN 2



**CFP** CROMO NERO SPAZZOLATO  
*BRUSHED BLACK CHROME*  
FIN 2



TABELLA FINITURE FINISHING TABLE

Crea uniche combinazioni di arredo personalizzando la rubinetteria di bagno e cucina con le opzioni di finitura. Un ventaglio di 8 colori, oltre al cromato, che si inseriscono con facilità in ambienti sia classici che moderni per rispondere alle esigenze stilistiche dei ogni progetto creativo.

Create unique furniture combinations for bathroom and kitchen by customizing the faucets with the finishing options. A range of 8 colours, in addition to chrome, that easily fit into both classic and modern interiors to meet the stylistic needs of all Your creative designs.

Verifica qui i colori di finitura disponibili per ogni collezione di rubinetteria:

Check here the finishing colours available for each faucet collection:

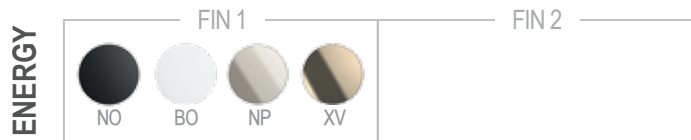
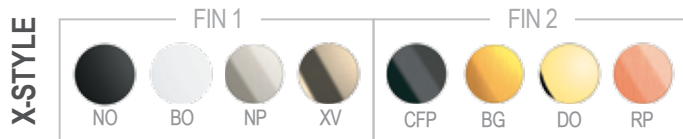

# NEWS RUBINETTERIA

## FAUCETS NEWS







# CELEBRITY



CELEBRITY è una collezione di miscelatori monocomando dallo stile elegante e sofisticato. Un design senza tempo impreziosito dagli intarsi di 3 differenti modelli di maniglie.  
Cartuccia diametro 25mm, 35mm per le figure a incasso.

*CELEBRITY is a collection of single-lever mixers with an elegant and sophisticated style. A timeless design enriched by the inlays of 3 different handle models.  
25mm diameter cartridge, 35mm for the built-in items.*



AVAILABLE  
FROM  
2024

**CELEBRITY**  
**OPZIONI LEVA *LEVER OPTIONS***



LEVA / *LEVER*  
**CHESTER**



LEVA / *LEVER*  
**DUNE**





LEVA / *LEVER*

**BOLD**

CELEBRITY  
OPZIONI DI FINITURA *FINISHING OPTIONS*





**BG** ORO SPAZZOLATO  
BRUSHED GOLD  
CEC57BG

**CR**



cromo  
chrome

CR

**FIN 1**



nero opaco  
matt black

NO



bianco opaco  
matt white

BO



visual inox  
visual steel

XV

**FIN 2**



cromo nero spazzolato  
brushed black chrome

CFP



oro spazzolato  
brushed gold

BG



oro lucido  
shiny gold

DO



rame spazzolato  
brushed copper

RP





**RP** RAME SPAZZOLATO  
*BRUSHED COPPER*

CED12RP

**CFP** CROMO NERO SPAZZOLATO  
*BRUSHED BLACK CHROME*

CEB12CFP



## OPZIONE LEVA - LEVER OPTION

La collezione è disponibile con tre varianti di maniglia, identificate dalle prime tre lettere del codice prodotto. Indicare la preferenza al momento dell'ordine.

This collection is available with three lever options, identified by the first three letters of the product code. Show your preference when ordering.



## MISCELATORI LAVABO - WASHBASIN MIXERS



### CEC10

Miscelatore monocomando per lavabo, con scarico.  
*Single-lever basin mixer, with pop-up waste.*



### CEC10ACC

Miscelatore monocomando per lavabo, modello "A" altezza media, con scarico click-clack con troppo-pieno incluso.  
*Single-lever basin mixer, model "A" medium height, with click-clack waste and overflow.*



### CEC10LXL

Miscelatore monocomando alto per lavabo, misura XL, scarico click-clack con troppo-pieno incluso.  
*High single-lever washbasin mixer, XL size, with "click-clack" waste and overflow.*



### CEC12

Miscelatore monocomando per lavabo, senza scarico e senza foro posteriore sul corpo.  
*Single-lever basin mixer, without waste and without rear body hole.*



### CEC12A

Miscelatore monocomando per lavabo, modello "A" altezza media, senza scarico e senza foro sul corpo.  
*Single-lever basin mixer, model "A" medium height, without pop-up waste and with no rear hole.*



### CEC11LXL

Miscelatore monocomando alto per lavabo, misura XL, scarico non incluso.  
*High single-lever washbasin mixer, XL size, waste not included.*



**CEC57**  
Miscelatore monocomando per lavabo a due fori. Scarico non incluso.  
*2-hole single-lever basin mixer. Waste not included.*



**CEC57L**  
Miscelatore monocomando per lavabo a due fori, con bocca L. Scarico non incluso.  
*2-hole single-lever basin mixer, with L spout. Waste not included.*

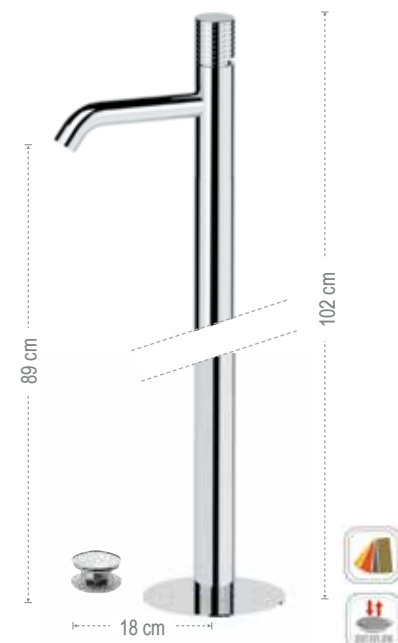

**CEC18**  
Miscelatore monocomando da pavimento per lavabo, scarico click-clack con troppopieno incluso.  
*Floor mounting single-lever basin mixer, click-clack waste with overflow included.*

MISCELATORI PER LAVABO A INCASSO - BUILT-IN WASHBASIN MIXER



**CEC15**  
Miscelatore monocomando a incasso per lavabo. Piastra ultra-piatta. Lunghezza bocca 17 cm.  
*Single-lever built-it basin mixer. Ultra-flat flange. Spout length 17 cm.*



**CEC15P**  
Miscelatore monocomando a incasso per lavabo, su due piastre tonde separate. Lunghezza bocca 17 cm.  
*Built-in single-lever basin mixer with two separate round plates. Spout length 17 cm.*

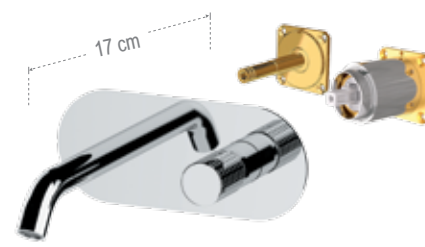

**CEC15KB**  
Miscelatore monocomando a incasso per lavabo da abbinare al box incasso. Piastra ultra-piatta. Lunghezza bocca 17 cm.  
*Single-lever built-in basin mixer, with ultra-flat wall flange. To match with the built-in box. Spout length 17 cm.*



**CEC15L**  
Miscelatore monocomando a incasso per lavabo. Piastra ultra-piatta. Lunghezza bocca 19 cm.  
*Single-lever built-it basin mixer. Ultra-flat flange. Spout length 19 cm.*



**CEC15PL**  
Miscelatore monocomando a incasso per lavabo, su due piastre tonde separate. Lunghezza bocca 19 cm.  
*Built-in single-lever basin mixer with two separate round plates. Spout length 19 cm.*

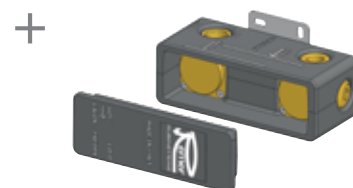

**RRBOX15**  
Box da incasso per miscelatore monocomando a incasso per lavabo.  
*Built-in box for single-lever built-in basin mixer.*



## MISCELATORI PER BIDET - BIDET MIXERS



### CEC20

Miscelatore monocomando per bidet, con scarico.

*Single-lever bidet mixer, with pop-up waste.*



### CEC22

Miscelatore monocomando per bidet, senza scarico e senza foro posteriore sul corpo.

*Single-lever bidet mixer, without waste and without rear body hole.*



### CEC65W

Set shut-off comprensivo di: miscelatore a incasso con supporto doccia/presa acqua, doccetta a pulsante(332OW), tutto in ottone. Flessibile doccia cm 120.

*Shut-off set including: built-in mixer with shower holder/water punch on flange, shut-off hand shower (332OW), all in brass. Flexible hose cm 120.*

## MISCELATORI PER VASCA E DOCCIA - SHOWER AND BATH MIXERS



### CEC02

Miscelatore monocomando per vasca, con kit doccetta in ottone ad 1 funzione. Flessibile 150cm.

*Wall mounted single-lever bath mixer with 1-function brass hand shower kit. 150cm flexible hose.*



### CEC05

Miscelatore monocomando per vasca, senza kit doccia.

*Wall mounted single-lever bath mixer, without shower kit.*

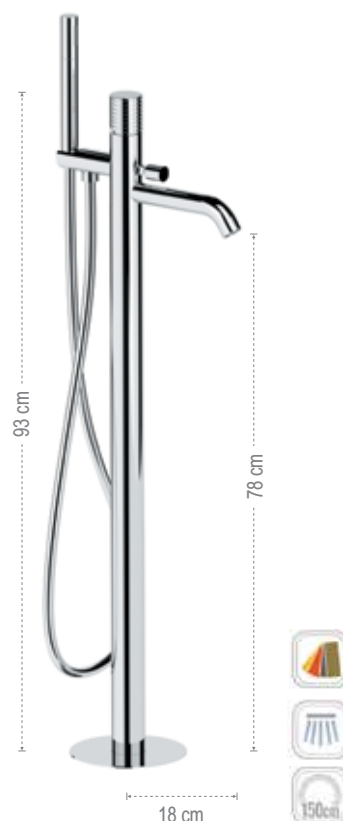

### CEC08

Miscelatore bordo vasca da pavimento, con deviatore e kit doccetta in ottone.

*Floor mounting single-lever bath mixer, with diverter and brass hand shower kit.*



CED08DO

2 VIE  
WAYS



### CEC53D2P

Set a incasso a 2 vie per vasca su piastre tonde separate ultra-piatte (3 piastre separate e incasso unico), include: miscelatore monocomando con deviatore a 2 uscite, bocca a muro; set doccia su piastra tonda ultra-piatta con presa acqua, supporto, doccetta e flessibile 150cm.

*2-way built-in set for bathtub on separate ultra-flat round plates (3 separate plates, one single built-in part), including: single-lever mixer, 2-way diverter, wall spout; Shower set on ultra-flat round plate with water connection, holder, hand shower and 150cm flexible hose.*



### CEC53D2

Set a incasso a 2 vie per vasca, include: miscelatore monocomando, deviatore a 2 uscite e bocca a muro su piastra unica rettangolare ultra-piatta; set doccia su piastra quadrata ultra-piatta con presa acqua, supporto integrato, doccetta in ottone e flessibile 150cm.

*2-way built-in set for bathtub, including: single-lever mixer, 2-way diverter and wall spout on a single ultra-flat rectangular plate; shower set on square ultra-flat plate with water connection, holder, brass handshower and 150cm flexible hose.*



### CEC54D2P

Set miscelatore a incasso a 2 vie per vasca/doccia su 3 piastre tonde ultra-piatte (piastre separate e incasso unico), include: miscelatore monocomando, deviatore a 2 uscite, bocca a muro. Da completare con la seconda uscita acqua.

*2-way built-in mixer set for bathtub / shower on 3 ultra-flat round plates (separate plates, one single built-in part), including: single-lever mixer, 2-way diverter, wall spout. To be completed with the second water outlet.*



### CEC54D2

Set miscelatore a incasso a 2 vie per vasca/doccia su piastra unica rettangolare ultra-piatta, include miscelatore monocomando, deviatore a 2 uscite, bocca a muro. Da completare con la seconda uscita.

*2-way built-in mixer set for bathtub / shower on single ultra-flat rectangular plate, including single-lever mixer, 2-way diverter, wall spout. To be completed with the second water outlet.*

3 VIE  
WAYS



### CEC54D3P

Set miscelatore a incasso a 3 vie per vasca/doccia su 3 piastre tonde ultra-piatte (piastre separate e incasso unico), include: miscelatore monocomando, deviatore a 3 uscite, bocca a muro. Da completare con la seconda e la terza uscita acqua.

*3-way built-in mixer set for bathtub / shower on 3 separate round plates (separate plates, one single built-in part), including: single-lever mixer, 3-way diverter, wall spout. To be completed with the second and the third water outlet.*



### CEC54D3

Set miscelatore a incasso a 3 vie per vasca/doccia su piastra unica rettangolare ultra-piatta, include miscelatore monocomando, deviatore a 3 uscite, bocca a muro. Da completare con la seconda e la terza uscita acqua.

*3-way built-in mixer set for bathtub / shower on single ultra-flat rectangular plate, including single-lever mixer, 3-way diverter, wall spout. To be completed with the second and the third water outlet.*

INCASSI DOCCIA - BUILT-IN MIXERS

1 VIA WAY



**CEC30L**

Miscelatore a incasso per doccia, su piastra tonda ultra-piatta.  
*Built-in shower mixer, ultra-flat round wall flange.*



**CEC30Q**

Miscelatore a incasso per doccia, su piastra quadrata ultra-piatta.  
*Built-in shower mixer, ultra-flat square wall flange.*



2 VIE WAYS



**CEC09L**

Miscelatore a incasso per vasca/doccia con deviatore a pressione, su piastra tonda ultra-piatta.  
*Built-in bath/shower mixer with push button diverter, on ultra-flat round wall flange.*



**CEC09Q**

Miscelatore a incasso per vasca/doccia con deviatore a pressione, su piastra quadrata ultra-piatta.  
*Built-in bath/shower mixer with push button diverter, on ultra-flat square wall flange.*



**CEC09H**

Miscelatore a incasso per vasca/doccia con deviatore a 2 vie a vitone ceramico, su piastra tonda. Per selezionare l'uscita desiderata, la manopola del deviatore deve essere ruotata da una posizione all'altra.  
*Built-in bath/shower mixer with 2-way diverter with ceramic head valve, on round wall flange. To select the desired output, the diverter knob must be turned from one position to the other.*



**CEC09HG**

Miscelatore a incasso per vasca/doccia con deviatore a 2 vie a vitone ceramico, su piastra rettangolare. Per selezionare l'uscita desiderata, la manopola del deviatore deve essere ruotata da una posizione all'altra.  
*Built-in bath/shower mixer with 2-way diverter with ceramic head valve, on rectangular wall flange. To select the desired output, the diverter knob must be turned from one position to the other.*







### CEC09HRG

Miscelatore a incasso per vasca/doccia con deviatore a 2 vie con vitone ceramico, su piastra rettangolare, installazione orizzontale. Per selezionare l'uscita desiderata, la manopola del deviatore deve essere ruotata da una posizione all'altra.

*Built-in bath/shower mixer with 2-way diverter with ceramic head valve, on rectangular plate, horizontal mounting. To select the desired output, the diverter knob must be turned from one position to the other.*



### CEC92ZP

Miscelatore a incasso per vasca/doccia con deviatore a 2 vie di tipo meccanico. Due piastre tonde ultra piatte. Parte a incasso unica, installazione orizzontale. Per selezionare l'uscita desiderata, posizionare la manopola del deviatore sulla posizione corrispondente.

*Built-in bath/shower mixer with 2-way mechanical diverter. Two ultra-flat round plates. Single built-in part, horizontal mounting. To select the desired water outlet, turn the diverter knob to the corresponding position.*



### CEC92Z

Miscelatore a incasso per vasca/doccia con deviatore a 2 vie di tipo meccanico. Piastra rettangolare ultra piatta, installazione orizzontale. Per selezionare l'uscita desiderata, posizionare la manopola del deviatore sulla posizione corrispondente.

*Built-in bath/shower mixer with 2-way mechanical diverter. Ultra-flat rectangular plate, horizontal mounting. To select the desired water outlet, turn the diverter knob to the corresponding position.*



### CEC97D2P

Set miscelatore a incasso a 2 vie per vasca/doccia su 3 piastre tonde ultra-piatte (parte a incasso unica), include: miscelatore, deviatore a 2 uscite, presa acqua con supporto, doccetta in ottone e flessibile 150 cm. Da completare con la seconda uscita.

*2-way built-in shower mixer set on 3 ultra-flat round plates (1 single built-in part), including: mixer, 2-way diverter, water connection with holder, brass hand shower and 150cm flexible hose. To be completed with the second water outlet.*



### CEC97D2

Set miscelatore a incasso a 2 vie per vasca/doccia su piastra rettangolare ultra-piatta, include: miscelatore, deviatore a 2 uscite, presa acqua con supporto, doccetta in ottone e flessibile 150 cm. Da completare con la seconda uscita.

*2-way built-in shower mixer set on ultra-flat rectangular plate, including: mixer, 2-way diverter, water connection with holder, brass hand shower and 150cm flexible hose. To be completed with the second water outlet.*

3 VIE  
WAYS**CEC93ZP**

Miscelatore a incasso per vasca/doccia con deviatore a 3 vie di tipo meccanico. Due piastre tonde ultra piatte. Parte a incasso unica, installazione orizzontale. Per selezionare l'uscita desiderata, posizionare la manopola del deviatore sulla posizione corrispondente.

*Built-in bath/shower mixer with 3-way mechanical diverter. Two ultra-flat round plates. Single built-in part, horizontal mounting. To select the desired water outlet, turn the diverter knob to the corresponding position.*

**CEC93Z**

Miscelatore a incasso per vasca/doccia con deviatore a 3 vie di tipo meccanico. Piastra rettangolare ultra piatta, installazione orizzontale. Per selezionare l'uscita desiderata, posizionare la manopola del deviatore sulla posizione corrispondente.

*Built-in bath/shower mixer with 3-way mechanical diverter. Ultra-flat rectangular plate, horizontal mounting. To select the desired water outlet, turn the diverter knob to the corresponding position.*

**CEC97D3P**

Set miscelatore a incasso a 3 vie per vasca/doccia su 3 piastre tonde ultra-piatte (parte a incasso unica), include: miscelatore, deviatore a 3 uscite, presa acqua con supporto, doccetta in ottone e flessibile 150 cm. Da completare con la seconda e la terza uscita acqua.

*3-way built-in bath/shower mixer set on 3 ultra-flat round plates (1 single built-in part), including: mixer, 3-way diverter, water connection with holder, brass hand shower and 150cm flexible hose. To be completed with the second and the third water outlet.*

**CEC97D3**

Set miscelatore a incasso a 3 vie per vasca/doccia su piastra rettangolare ultra-piatta, include: miscelatore, deviatore a 3 uscite, presa acqua con supporto, doccetta in ottone e flessibile 150 cm. Da completare con la seconda e la terza uscita acqua.

*3-way built-in shower mixer set on ultra-flat rectangular plate, including: mixer, 3-way diverter, water connection with holder, brass hand shower and 150cm flexible hose. To be completed with the second and the third water outlet.*

# METRICA



METRICA è una collezione di rubinetteria monocomando ideale per un ambiente moderno e accattivante. Il particolare design della leva di miscelazione dona stile e personalità all'intera figura. La collezione si sviluppa su una cartuccia dal diametro di 25mm, 35mm per le figure a incasso.

*METRICA is a collection of single-lever taps, perfect for a modern and attractive interior. The special design of the mixing lever adds style and personality to the entire figure. The collection is developed on a 25mm diameter cartridge, 35mm for the built-in items.*



AVAILABLE  
FROM  
2024



METRICA  
OPZIONI DI FINITURA *FINISHING OPTIONS*



**NO** NERO OPACO  
MATT BLACK

MC12NO



**DO** ORO LUCIDO  
*SHINY GOLD*

MC15DO

**CR**



cromo  
*chrome*

CR

**FIN 1**



nero opaco  
*matt black*

NO



bianco opaco  
*matt white*

BO



visual inox  
*visual steel*

XV

**FIN 2**



cromo nero spazzolato  
*brushed black chrome*

CFP



oro spazzolato  
*brushed gold*

BG



oro lucido  
*shiny gold*

DO



rame spazzolato  
*brushed copper*

RP



**REMER**  
RUBINETTERIE

**XV** VISUAL INOX  
VISUAL STEEL



**CFP** CROMO NERO SPAZZOLATO  
*BRUSHED BLACK CHROME*



## MISCELATORI LAVABO - WASHBASIN MIXERS



### MC10

Miscelatore monocomando per lavabo, con scarico.  
*Single-lever basin mixer, with pop-up waste.*



### MC10ACC

Miscelatore monocomando per lavabo, modello "A" altezza media, con scarico click-clack con troppo-pieno incluso.  
*Single-lever basin mixer, model "A" medium height, click-clack waste with overflow included.*



### MC10LXL

Miscelatore monocomando alto per lavabo, misura XL, scarico click-clack con troppo-pieno incluso.  
*High single-lever washbasin mixer, XL size, click-clack waste with overflow included.*



### MC12

Miscelatore monocomando per lavabo, senza scarico e senza foro posteriore sul corpo.  
*Single-lever basin mixer, without waste and without rear body hole.*



### MC12A

Miscelatore monocomando per lavabo, modello "A" altezza media, senza scarico e senza foro sul corpo.  
*Single-lever basin mixer, model "A" medium height, without pop-up waste and with no rear hole.*



### MC11LXL

Miscelatore monocomando alto per lavabo, misura XL, scarico non incluso.  
*High single-lever washbasin mixer, XL size, waste not included.*



### MC57

Miscelatore monocomando per lavabo a due fori. Scarico non incluso.  
*2-hole single-lever basin mixer. Waste not included.*



### MC57L

Miscelatore monocomando per lavabo a due fori, con bocca L. Scarico non incluso.  
*2-hole single-lever basin mixer, with L spout. Waste not included.*



### MC18

Miscelatore monocomando da pavimento per lavabo, scarico click-clack con troppopieno incluso.  
*Floor mounting single-lever basin mixer, click-clack waste with overflow included.*

MISCELATORI PER LAVABO A INCASSO - BUILT-IN WASHBASIN MIXER



**MC15**

Miscelatore monocomando a incasso per lavabo. Piastra ultra-piatta. Lunghezza bocca 17 cm.  
*Single-lever built-it basin mixer. Ultra-flat flange. Spout length 17 cm.*



**MC15P**

Miscelatore monocomando a incasso per lavabo, su due piastre tonde separate. Lunghezza bocca 17 cm.  
*Built-in single-lever basin mixer on two separate round plates. Spout length 17 cm.*

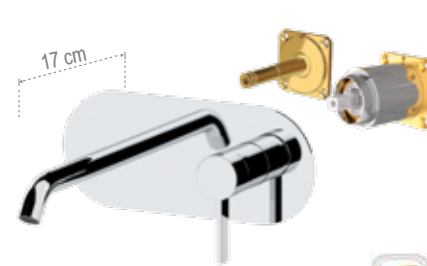

**MC15KB**

Miscelatore monocomando a incasso per lavabo da abbinare al box incasso. Piastra ultra-piatta. Lunghezza bocca 17 cm.  
*Single-lever built-in basin mixer, with ultra-flat wall flange. To match with the built-in box. Spout length 17 cm.*



**MC15L**

Miscelatore monocomando a incasso per lavabo. Piastra ultra-piatta. Lunghezza bocca 19 cm.  
*Single-lever built-in basin mixer. Ultra-flat flange. Spout length 19 cm.*



**MC15PL**

Miscelatore monocomando a incasso per lavabo, su due piastre tonde separate. Lunghezza bocca 19 cm.  
*Built-in single-lever basin mixer on two separate round plates. Spout length 19 cm.*

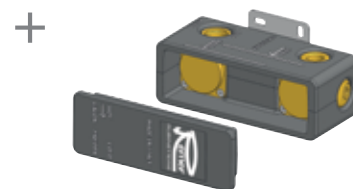

**RRBOX15**

Box da incasso per miscelatore monocomando a incasso per lavabo.  
*Built-in box for single-lever built-in basin mixer.*

MISCELATORI PER BIDET - BIDET MIXERS



**MC20**

Miscelatore monocomando per bidet, con scarico.  
*Single-lever bidet mixer, with pop-up waste.*



**MC22**

Miscelatore monocomando per bidet, senza scarico e senza foro posteriore.  
*Single-lever bidet mixer, without waste and without rear hole.*



**MC65W**

Set shut-off comprensivo di: miscelatore a incasso con supporto doccia/presa acqua, doccetta a pulsante (332OW), tutto in ottone. Flessibile doccia cm 120.  
*Shut-off set including: built-in mixer with shower holder/water punch on flange, shut-off hand shower (332OW), all in brass. Flexible hose cm 120.*



**MC02**

Miscelatore monocomando per vasca, con kit doccia in ottone ad 1 funzione. Flessibile 150cm.

*Wall mounted single-lever bath mixer with 1-function brass hand shower kit. 150cm flexible hose.*



**MC05**

Miscelatore monocomando per vasca, senza kit doccia.

*Wall mounted single-lever bath mixer, without shower kit.*

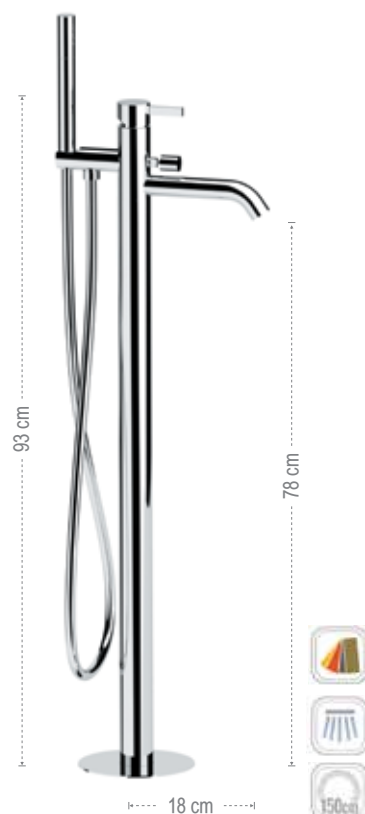

**MC08**

Miscelatore bordo vasca da pavimento, con deviatore e kit doccia in ottone.

*Floor mounting single-lever bath mixer, with diverter and brass hand shower kit.*



**MC027MD**

Miscelatore monocomando per vasca, con kit doccia in ABS ad 1 funzione e getti in silicone. Flessibile 150cm.

*Wall mounted single-lever bath mixer with 1-function ABS hand shower kit with jets in silicone. 150cm flexible hose.*



**MC38**

Miscelatore monocomando esterno per doccia, con kit doccia in ottone ad 1 funzione. Flessibile 150cm.

*Wall mounted exposed single-lever shower mixer with 1-function brass hand shower kit. 150cm flexible hose.*



**MC33**

Miscelatore monocomando esterno per doccia, senza kit doccia.

*Wall mounted exposed single-lever shower mixer, without shower kit.*

2 VIE  
WAYS



**MC53D2P**

Set a incasso a 2 vie per vasca su piastre tonde separate ultra-piatte (3 piastre separate e incasso unico), include: miscelatore monocomando con deviatore a 2 uscite, bocca a muro; set doccia su piastra tonda ultra-piatta con presa acqua, supporto, doccetta e flessibile 150cm.

*2-way built-in set for bathtub on separate ultra-flat round plates (3 separate plates, one single built-in part), including: single-lever mixer, 2-way diverter, wall spout; Shower set on ultra-flat round plate with water connection, holder, hand shower and 150cm flexible hose.*



**MC53D2**

Set a incasso a 2 vie per vasca, include: miscelatore monocomando, deviatore a 2 uscite e bocca a muro su piastra unica rettangolare ultra-piatta; set doccia su piastra quadrata ultra-piatta con presa acqua, supporto integrato, doccetta in ottone e flessibile 150cm.

*2-way built-in set for bathtub, including: single-lever mixer, 2-way diverter and wall spout on a single ultra-flat rectangular plate; shower set on square ultra-flat plate with water connection, holder, brass handshower and 150cm flexible hose.*



**MC54D2P**

Set miscelatore a incasso a 2 vie per vasca/doccia su 3 piastre tonde ultra-piatte (piastre separate e incasso unico), include: miscelatore monocomando, deviatore a 2 uscite, bocca a muro. Da completare con la seconda uscita acqua.

*2-way built-in mixer set for bathtub / shower on 3 ultra-flat round plates (separate plates, one single built-in part), including: single-lever mixer, 2-way diverter, wall spout. To be completed with the second water outlet.*

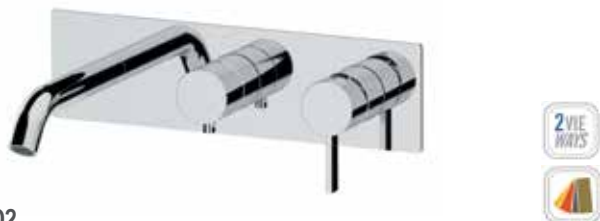

**MC54D2**

Set miscelatore a incasso a 2 vie per vasca/doccia su piastra unica rettangolare ultra-piatta, include miscelatore monocomando, deviatore a 2 uscite, bocca a muro. Da completare con la seconda uscita.

*2-way built-in mixer set for bathtub / shower on single ultra-flat rectangular plate, including single-lever mixer, 2-way diverter, wall spout. To be completed with the second water outlet.*

3 VIE  
WAYS



**MC54D3P**

Set miscelatore a incasso a 3 vie per vasca/doccia su 3 piastre tonde ultra-piatte (piastre separate e incasso unico), include: miscelatore monocomando, deviatore a 3 uscite, bocca a muro. Da completare con la seconda e la terza uscita acqua.

*3-way built-in mixer set for bathtub / shower on 3 separate round plates (separate plates, one single built-in part), including: single-lever mixer, 3-way diverter, wall spout. To be completed with the second and the third water outlet.*



**MC54D3**

Set miscelatore a incasso a 3 vie per vasca/doccia su piastra unica rettangolare ultra-piatta, include miscelatore monocomando, deviatore a 3 uscite, bocca a muro. Da completare con la seconda e la terza uscita acqua.

*3-way built-in mixer set for bathtub / shower on single ultra-flat rectangular plate, including single-lever mixer, 3-way diverter, wall spout. To be completed with the second and the third water outlet.*



## INCASSI DOCCIA - BUILT-IN MIXERS

1 VIA WAY



### MC30L

Miscelatore a incasso per doccia, su piastra tonda ultra-piatta.  
*Built-in shower mixer, ultra-flat round wall flange.*



### MC30Q

Miscelatore a incasso per doccia, su piastra quadrata ultra-piatta.  
*Built-in shower mixer, ultra-flat square wall flange.*



2 VIE WAYS



### MC09L

Miscelatore a incasso per vasca/doccia con deviatore a pressione, su piastra tonda ultra-piatta.  
*Built-in bath/shower mixer with push button diverter, on ultra-flat round wall flange.*



### MC09Q

Miscelatore a incasso per vasca/doccia con deviatore a pressione, su piastra quadrata ultra-piatta.  
*Built-in bath/shower mixer with push button diverter, on ultra-flat square wall flange.*



### MC09H

Miscelatore a incasso per vasca/doccia con deviatore a 2 vie a vitone ceramico, su piastra tonda. Per selezionare l'uscita desiderata, la manopola del deviatore deve essere ruotata da una posizione all'altra.  
*Built-in bath/shower mixer with 2-way diverter with ceramic head valve, on round wall flange. To select the desired output, the diverter knob must be turned from one position to the other.*



### MC09HG

Miscelatore a incasso per vasca/doccia con deviatore a 2 vie a vitone ceramico, su piastra rettangolare. Per selezionare l'uscita desiderata, la manopola del deviatore deve essere ruotata da una posizione all'altra.  
*Built-in bath/shower mixer with 2-way diverter with ceramic head valve, on rectangular wall flange. To select the desired output, the diverter knob must be turned from one position to the other.*





MC09HGXV



### MC09HRG

Miscelatore a incasso per vasca/doccia con deviatore a 2 vie con vitone ceramico, su piastra rettangolare, installazione orizzontale. Per selezionare l'uscita desiderata, la manopola del deviatore deve essere ruotata da una posizione all'altra.

*Built-in bath/shower mixer with 2-way diverter with ceramic head valve, on rectangular plate, horizontal mounting. To select the desired output, the diverter knob must be turned from one position to the other.*



### MC92ZP

Miscelatore a incasso per vasca/doccia con deviatore a 2 vie di tipo meccanico. Due piastre tonde ultra piatte. Parte a incasso unica, installazione orizzontale. Per selezionare l'uscita desiderata, posizionare la manopola del deviatore sulla posizione corrispondente.

*Built-in bath/shower mixer with 2-way mechanical diverter. Two ultra-flat round plates. Single built-in part, horizontal mounting. To select the desired water outlet, turn the diverter knob to the corresponding position.*



### MC92Z

Miscelatore a incasso per vasca/doccia con deviatore a 2 vie di tipo meccanico. Piastra rettangolare ultra piatta, installazione orizzontale. Per selezionare l'uscita desiderata, posizionare la manopola del deviatore sulla posizione corrispondente.

*Built-in bath/shower mixer with 2-way mechanical diverter. Ultra-flat rectangular plate, horizontal mounting. To select the desired water outlet, turn the diverter knob to the corresponding position.*



### MC97D2P

Set miscelatore a incasso a 2 vie per vasca/doccia su 3 piastre tonde ultra-piatte (parte a incasso unica), include: miscelatore, deviatore a 2 uscite, presa acqua con supporto, doccetta in ottone e flessibile 150 cm. Da completare con la seconda uscita.

*2-way built-in shower mixer set on 3 ultra-flat round plates (1 single built-in part), including: mixer, 2-way diverter, water connection with holder, brass hand shower and 150cm flexible hose. To be completed with the second water outlet.*



### MC97D2

Set miscelatore a incasso a 2 vie per vasca/doccia su piastra rettangolare ultra-piatta, include: miscelatore, deviatore a 2 uscite, presa acqua con supporto, doccetta in ottone e flessibile 150 cm. Da completare con la seconda uscita.

*2-way built-in shower mixer set on ultra-flat rectangular plate, including: mixer, 2-way diverter, water connection with holder, brass hand shower and 150cm flexible hose. To be completed with the second water outlet.*



**MC93ZP**

Miscelatore a incasso per vasca/doccia con deviatore a 3 vie di tipo meccanico. Due piastre tonde ultra piatte. Parte a incasso unica, installazione orizzontale. Per selezionare l'uscita desiderata, posizionare la manopola del deviatore sulla posizione corrispondente.

*Built-in bath/shower mixer with 3-way mechanical diverter. Two ultraflat round plates. Single built-in part, horizontal mounting. To select the desired water outlet, turn the diverter knob to the corresponding position.*



**MC93Z**

Miscelatore a incasso per vasca/doccia con deviatore a 3 vie di tipo meccanico. Piastra rettangolare ultra piatta, installazione orizzontale. Per selezionare l'uscita desiderata, posizionare la manopola del deviatore sulla posizione corrispondente.

*Built-in bath/shower mixer with 3-way mechanical diverter. Ultra-flat rectangular plate, horizontal mounting. To select the desired water outlet, turn the diverter knob to the corresponding position.*



**MC97D3P**

Set miscelatore a incasso a 3 vie per vasca/doccia su 3 piastre tonde ultra-piatte (parte a incasso unica), include: miscelatore, deviatore a 3 uscite, presa acqua con supporto, doccetta in ottone e flessibile 150 cm. Da completare con la seconda e la terza uscita acqua.

*3-way built-in bath/shower mixer set on 3 ultra-flat round plates (1 single built-in part), including: mixer, 3-way diverter, water connection with holder, brass hand shower and 150cm flexible hose. To be completed with the second and the third water outlet.*



**MC97D3**

Set miscelatore a incasso a 3 vie per vasca/doccia su piastra rettangolare ultra-piatta, include: miscelatore, deviatore a 3 uscite, presa acqua con supporto, doccetta in ottone e flessibile 150 cm. Da completare con la seconda e la terza uscita acqua.

*3-way built-in shower mixer set on ultra-flat rectangular plate, including: mixer, 3-way diverter, water connection with holder, brass hand shower and 150cm flexible hose. To be completed with the second and the third water outlet.*



# CHRONO



CHRONO è una collezione di miscelatori monocomando con un forte richiamo agli ingranaggi del tempo. La scelta di rubinetteria ideale per accompagnare uno stile di interni urbano e industriale. Cartuccia diametro 25mm, 35mm per le figure a incasso.

*CHRONO is a collection of single lever mixers with a strong reference to the gears of time. The perfect choice of faucets to match an industrial and urban interior style.  
25mm diameter cartridge, 35mm for the built-in items.*



AVAILABLE  
FROM  
2024

**CHRONO**  
**OPZIONI DI FINITURA** *FINISHING OPTIONS*



**NO** NERO OPACO  
MATT BLACK

CH12NO



**XV** VISUAL INOX  
VISUAL STEEL

CH12XV

**CR**



cromo  
*chrome*

CR

**FIN 1**



nero opaco  
*matt black*

NO



bianco opaco  
*matt white*

BO



visual inox  
*visual steel*

XV

**FIN 2**



cromo nero spazzolato  
*brushed black chrome*

CFP



oro spazzolato  
*brushed gold*

BG



oro lucido  
*shiny gold*

DO



rame spazzolato  
*brushed copper*

RP





**BO** BIANCO OPACO  
MATT WHITE  
CH10LXLBO



## MISCELATORI LAVABO - WASHBASIN MIXERS



### CH10

Miscelatore monocomando per lavabo, con scarico.  
*Single-lever basin mixer, with pop-up waste.*



### CH12

Miscelatore monocomando per lavabo, senza scarico e senza foro posteriore sul corpo.  
*Single-lever basin mixer, without waste and without rear body hole.*



### CH10ACC

Miscelatore monocomando per lavabo, modello "A" altezza media, scarico click-clack con troppo-pieno incluso.  
*Single-lever basin mixer, model "A" medium height, click-clack waste with overflow included.*



### CH12A

Miscelatore monocomando per lavabo, modello "A" altezza media, senza scarico e senza foro sul corpo.  
*Single-lever basin mixer, model "A" medium height, without pop-up waste and with no rear hole.*



### CH10LXL

Miscelatore monocomando alto per lavabo, misura XL, scarico click-clack con troppo-pieno incluso.  
*High single-lever washbasin mixer, XL size, click-clack waste with overflow included.*



### CH11LXL

Miscelatore monocomando alto per lavabo, misura XL, scarico non incluso.  
*High single-lever washbasin mixer, XL size, waste not included.*

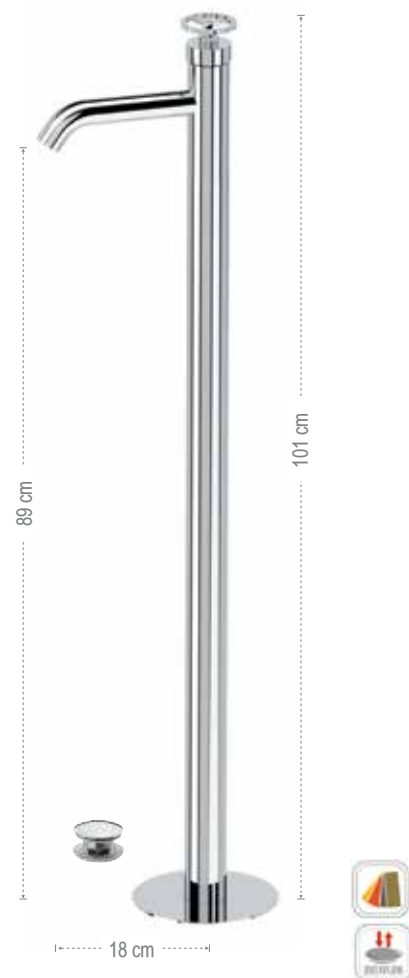

### CH18

Miscelatore monocomando da pavimento per lavabo, scarico click-clack con troppo-pieno incluso.  
*Floor mounting single-lever basin mixer, click-clack waste with overflow included.*



MISCELATORI PER LAVABO A INCASSO - BUILT-IN WASHBASIN MIXER



**CH15**

Miscelatore monocomando a incasso per lavabo. Piastra ultra-piatta. Lunghezza bocca 17 cm

*Single-lever built-it basin mixer. Ultra-flat flange. Spout length 17 cm.*



**CH15P**

Miscelatore monocomando a incasso per lavabo, su due piastre tonde separate. Lunghezza bocca 17 cm.

*Built-in single-lever basin mixer with two separate round plates. Spout length 17 cm.*

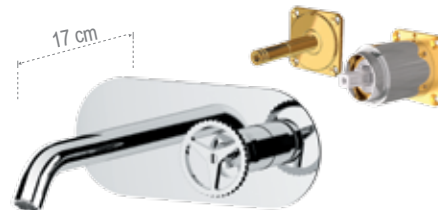

**CH15KB**

Miscelatore monocomando a incasso per lavabo da abbinare al box incasso. Piastra ultra-piatta. Lunghezza bocca 17 cm.

*Single-lever built-in basin mixer, with ultra-flat wall flange. To match with the built-in box. Spout length 17 cm.*



**CH15L**

Miscelatore monocomando a incasso per lavabo. Piastra ultra-piatta. Lunghezza bocca 19 cm.

*Single-lever built-it basin mixer. Ultra-flat flange. Spout length 19 cm.*



**CH15PL**

Miscelatore monocomando a incasso per lavabo, su due piastre tonde separate. Lunghezza bocca 19 cm.

*Built-in single-lever basin mixer with two separate round plates. Spout length 19 cm.*

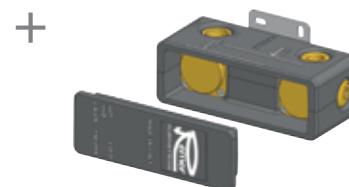

**RRBOX15**

Box da incasso per miscelatore monocomando a incasso per lavabo.

*Built-in box for single-lever built-in basin mixer.*

MISCELATORI PER BIDET - BIDET MIXERS



**CH20**

Miscelatore monocomando per bidet, con scarico.

*Single-lever bidet mixer, with pop-up waste.*



**CH22**

Miscelatore monocomando per bidet, senza scarico e senza foro posteriore sul corpo.

*Single-lever bidet mixer, without waste and without rear body hole.*



**CH65W**

Set shut-off comprensivo di: miscelatore a incasso con supporto doccia/presa acqua, doccia a pulsante, tutto in ottone. Flessibile doccia cm 120.

*Shut-off set including: built-in mixer with shower holder/water punch on flange, shut-off hand shower, all in brass. Flexible hose cm 120.*





## MISCELATORI PER VASCA E DOCCIA - SHOWER AND BATH MIXERS



### CH02

Miscelatore monocomando per vasca, con kit doccia in ottone ad 1 funzione. Flessibile 150cm.

*Wall mounted single-lever bath mixer with 1-function brass hand shower kit. 150cm flexible hose.*

### CH05

Miscelatore monocomando per vasca, senza kit doccia.

*Wall mounted single-lever bath mixer, without shower kit.*



### CH08

Miscelatore bordo vasca da pavimento, con deviatore e kit doccia in ottone.

*Floor mounting single-lever bath mixer, with diverter and brass hand shower kit.*



CH08DO

2 VIE WAYS



**CH53D2P**

Set a incasso a 2 vie per vasca su piastre tonde separate ultra-piatte (3 piastre separate e incasso unico), include: miscelatore monocomando con deviatore a 2 uscite, bocca a muro; set doccia su piastra tonda ultra-piatta con presa acqua, supporto, doccetta e flessibile 150cm.

*2-way built-in set for bathtub on separate ultra-flat round plates (3 separate plates, one single built-in part), including: single-lever mixer, 2-way diverter, wall spout; Shower set on ultra-flat round plate with water connection, holder, hand shower and 150cm flexible hose.*



**CH53D2**

Set a incasso a 2 vie per vasca, include: miscelatore monocomando, deviatore a 2 uscite e bocca a muro su piastra unica rettangolare ultra-piatta; set doccia su piastra quadrata ultra-piatta con presa acqua, supporto integrato, doccetta in ottone e flessibile 150cm.

*2-way built-in set for bathtub, including: single-lever mixer, 2-way diverter and wall spout on a single ultra-flat rectangular plate; shower set on square ultra-flat plate with water connection, holder, brass handshower and 150cm flexible hose.*



**CH54D2P**

Set miscelatore a incasso a 2 vie per vasca/doccia su 3 piastre tonde ultra-piatte (piastre separate e incasso unico), include: miscelatore monocomando, deviatore a 2 uscite, bocca a muro. Da completare con la seconda uscita acqua.

*2-way built-in mixer set for bathtub / shower on 3 ultra-flat round plates (separate plates, one single built-in part), including: single-lever mixer, 2-way diverter, wall spout. To be completed with the second water outlet.*



**CH54D2**

Set miscelatore a incasso a 2 vie per vasca/doccia su piastra unica rettangolare ultra-piatta, include miscelatore monocomando, deviatore a 2 uscite, bocca a muro. Da completare con la seconda uscita.

*2-way built-in mixer set for bathtub / shower on single ultra-flat rectangular plate, including single-lever mixer, 2-way diverter, wall spout. To be completed with the second water outlet.*

3 VIE WAYS



**CH54D3P**

Set miscelatore a incasso a 3 vie per vasca/doccia su 3 piastre tonde ultra-piatte (piastre separate e incasso unico), include: miscelatore monocomando, deviatore a 3 uscite, bocca a muro. Da completare con la seconda e la terza uscita acqua.

*3-way built-in mixer set for bathtub / shower on 3 separate round plates (separate plates, one single built-in part), including: single-lever mixer, 3-way diverter, wall spout. To be completed with the second and the third water outlet.*



**CH54D3**

Set miscelatore a incasso a 3 vie per vasca/doccia su piastra unica rettangolare ultra-piatta, include miscelatore monocomando, deviatore a 3 uscite, bocca a muro. Da completare con la seconda e la terza uscita acqua.

*3-way built-in mixer set for bathtub / shower on single ultra-flat rectangular plate, including single-lever mixer, 3-way diverter, wall spout. To be completed with the second and the third water outlet.*

## INCASSI DOCCIA - BUILT-IN MIXERS

1 VIA WAY



### CH30L

Miscelatore a incasso per doccia, su piastra tonda ultra-piatta.

*Built-in shower mixer, ultra-flat round wall flange.*



### CH30Q

Miscelatore a incasso per doccia, su piastra quadrata ultra-piatta.

*Built-in shower mixer, ultra-flat square wall flange.*



2 VIE WAYS



### CH92ZP

Miscelatore a incasso per vasca/doccia con deviatore a 2 vie di tipo meccanico. Due piastre tonde ultra piatte. Parte a incasso unica, installazione orizzontale. Per selezionare l'uscita desiderata, posizionare la manopola del deviatore sulla posizione corrispondente.

*Built-in bath/shower mixer with 2-way mechanical diverter. Two ultra-flat round plates. Single built-in part, horizontal mounting. To select the desired water outlet, turn the diverter knob to the corresponding position.*



### CH92Z

Miscelatore a incasso per vasca/doccia con deviatore a 2 vie di tipo meccanico. Piastra rettangolare ultra piatta, installazione orizzontale. Per selezionare l'uscita desiderata, posizionare la manopola del deviatore sulla posizione corrispondente.

*Built-in bath/shower mixer with 2-way mechanical diverter. Ultra-flat rectangular plate, horizontal mounting. To select the desired water outlet, turn the diverter knob to the corresponding position.*



### CH97D2P

Set miscelatore a incasso a 2 vie per vasca/doccia su 3 piastre tonde ultra-piatte (parte a incasso unica), include: miscelatore, deviatore a 2 uscite, presa acqua con supporto, doccetta in ottone e flessibile 150 cm. Da completare con la seconda uscita.

*2-way built-in shower mixer set on 3 ultra-flat round plates (1 single built-in part), including: mixer, 2-way diverter, water connection with holder, brass hand shower and 150cm flexible hose. To be completed with the second water outlet.*

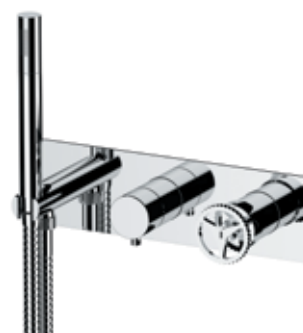

### CH97D2

Set miscelatore a incasso a 2 vie per vasca/doccia su piastra rettangolare ultra-piatta, include: miscelatore, deviatore a 2 uscite, presa acqua con supporto, doccetta in ottone e flessibile 150 cm. Da completare con la seconda uscita.

*2-way built-in shower mixer set on ultra-flat rectangular plate, including: mixer, 2-way diverter, water connection with holder, brass hand shower and 150cm flexible hose. To be completed with the second water outlet.*



3 VIE  
WAYS



### CH93ZP

Miscelatore a incasso per vasca/doccia con deviatore a 3 vie di tipo meccanico. Due piastre tonde ultra piatte. Parte a incasso unica, installazione orizzontale. Per selezionare l'uscita desiderata, posizionare la manopola del deviatore sulla posizione corrispondente.

*Built-in bath/shower mixer with 3-way mechanical diverter. Two ultra-flat round plates. Single built-in part, horizontal mounting. To select the desired water outlet, turn the diverter knob to the corresponding position.*



### CH93Z

Miscelatore a incasso per vasca/doccia con deviatore a 3 vie di tipo meccanico. Piastra rettangolare ultra piatta, installazione orizzontale. Per selezionare l'uscita desiderata, posizionare la manopola del deviatore sulla posizione corrispondente.

*Built-in bath/shower mixer with 3-way mechanical diverter. Ultra-flat rectangular plate, horizontal mounting. To select the desired water outlet, turn the diverter knob to the corresponding position.*



### CH97D3P

Set miscelatore a incasso a 3 vie per vasca/doccia su 3 piastre tonde ultra-piatte (parte a incasso unica), include: miscelatore, deviatore a 3 uscite, presa acqua con supporto, doccetta in ottone e flessibile 150 cm. Da completare con la seconda e la terza uscita acqua.

*3-way built-in bath/shower mixer set on 3 ultra-flat round plates (1 single built-in part), including: mixer, 3-way diverter, water connection with holder, brass hand shower and 150cm flexible hose. To be completed with the second and the third water outlet.*

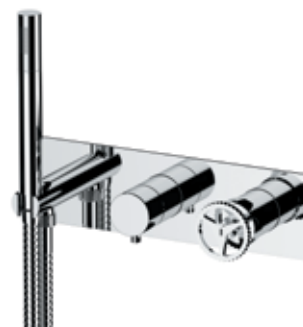

### CH97D3

Set miscelatore a incasso a 3 vie per vasca/doccia su piastra rettangolare ultra-piatta, include: miscelatore, deviatore a 3 uscite, presa acqua con supporto, doccetta in ottone e flessibile 150 cm. Da completare con la seconda e la terza uscita acqua.

*3-way built-in shower mixer set on ultra-flat rectangular plate, including: mixer, 3-way diverter, water connection with holder, brass hand shower and 150cm flexible hose. To be completed with the second and the third water outlet.*



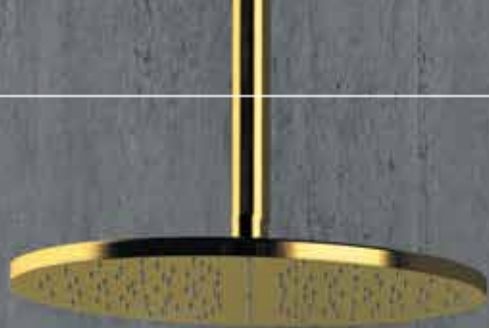

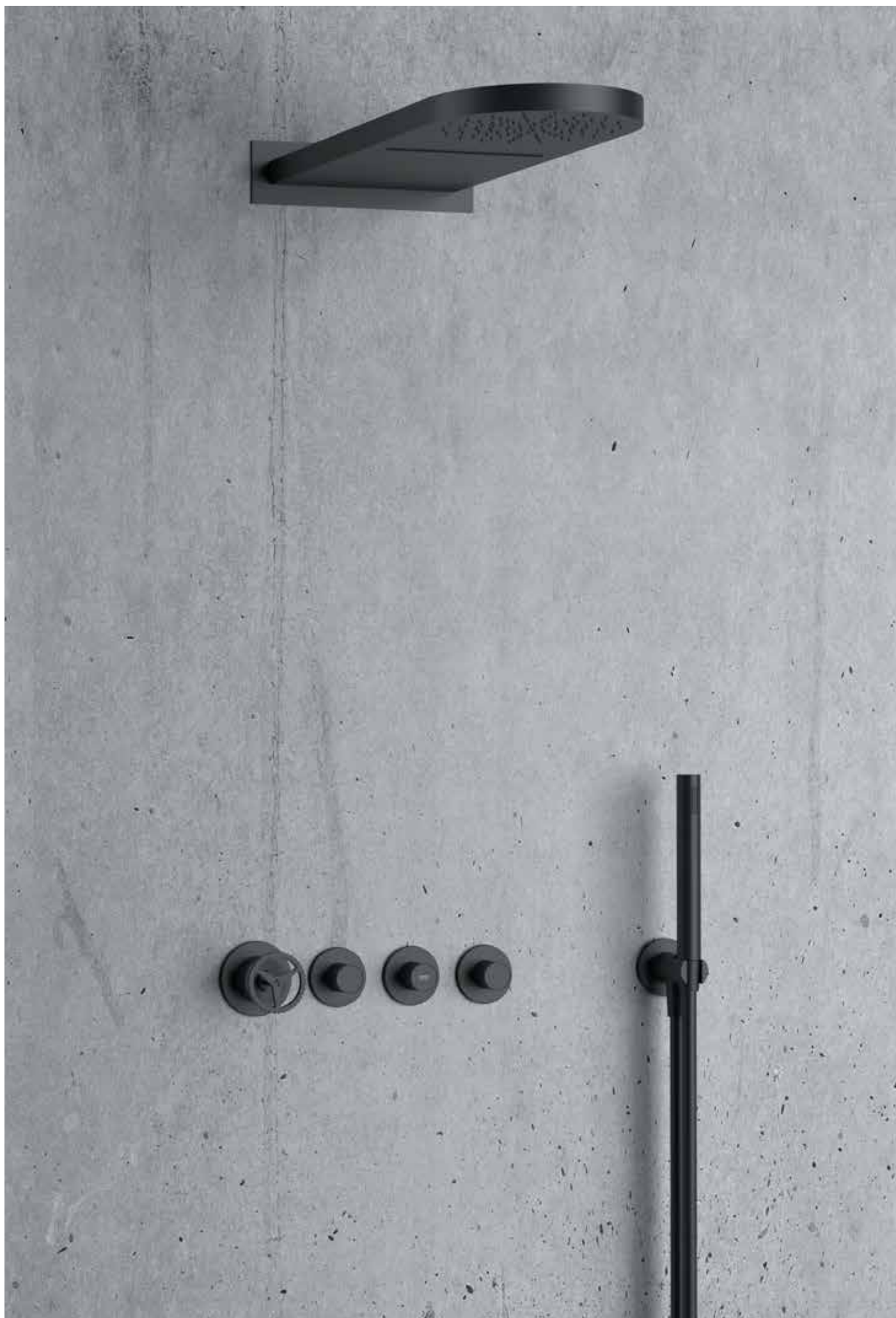

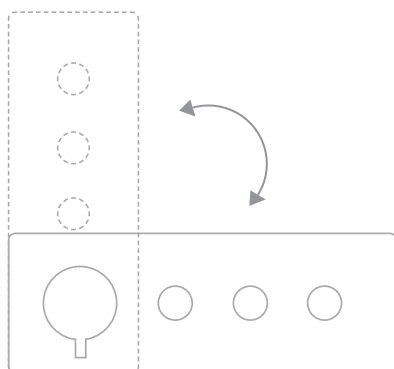

CON PIASTRA RETTANGOLARE  
WITH RECTANGULAR PLATE



#### CH98D3

Miscelatore a incasso a 3 vie per vasca o doccia con deviatori singoli a vitone ceramico. Per azionare l'uscita desiderata, ruotare la manopola del deviatore corrispondente. Parte a incasso unica, installazione possibile sia in orizzontale che in verticale.

*3-way built-in mixer for bath or shower with single ceramic valve diverters. To open the desired water outlet, turn the knob of the corresponding diverter. Single recessed part, installation possible both horizontally and vertically.*



#### CH98D4

Miscelatore a incasso a 4 vie per vasca o doccia con deviatori singoli a vitone ceramico. Per azionare l'uscita desiderata, ruotare la manopola del deviatore corrispondente. Parte a incasso unica, installazione possibile sia in orizzontale che in verticale.

*4-way built-in mixer for bath or shower with single ceramic valve diverters. To open the desired water outlet, turn the knob of the corresponding diverter. Single recessed part, installation possible both horizontally and vertically.*



#### CH98D5

Miscelatore a incasso a 5 vie per vasca o doccia con deviatori singoli a vitone ceramico. Per azionare l'uscita desiderata, ruotare la manopola del deviatore corrispondente. Parte a incasso unica, installazione possibile sia in orizzontale che in verticale.

*5-way built-in mixer for bath or shower with single ceramic valve diverters. To open the desired water outlet, turn the knob of the corresponding diverter. Single recessed part, installation possible both horizontally and vertically.*

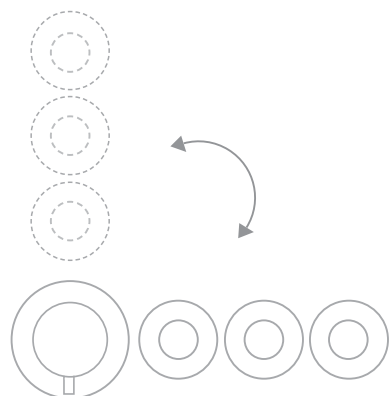

CON PIASTRE TONDE SEPARATE  
WITH SEPARATE ROUND PLATES



**CH98D3P**

Miscelatore a incasso a 3 vie per vasca o doccia con deviatori singoli a vitone ceramico. Per azionare l'uscita desiderata, ruotare la manopola del deviatore corrispondente. Parte a incasso unica, installazione possibile sia in orizzontale che in verticale.

*3-way built-in mixer for bath or shower with single ceramic valve diverters. To open the desired water outlet, turn the knob of the corresponding diverter. Single recessed part, installation possible both horizontally and vertically.*



**CH98D4P**

Miscelatore a incasso a 4 vie per vasca o doccia con deviatori singoli a vitone ceramico. Per azionare l'uscita desiderata, ruotare la manopola del deviatore corrispondente. Parte a incasso unica, installazione possibile sia in orizzontale che in verticale.

*4-way built-in mixer for bath or shower with single ceramic valve diverters. To open the desired water outlet, turn the knob of the corresponding diverter. Single recessed part, installation possible both horizontally and vertically.*



**CH98D5P**

Miscelatore a incasso a 5 vie per vasca o doccia con deviatori singoli a vitone ceramico. Per azionare l'uscita desiderata, ruotare la manopola del deviatore corrispondente. Parte a incasso unica, installazione possibile sia in orizzontale che in verticale.

*5-way built-in mixer for bath or shower with single ceramic valve diverters. To open the desired water outlet, turn the knob of the corresponding diverter. Single recessed part, installation possible both horizontally and vertically.*



# ATELIER





Nella collezione di miscelatori monocomando ATELIER, i dettagli decorativi dallo stile classico impreziosiscono le superfici di leva, basetta e aeratore, creando un equilibrio di assoluta eleganza con le forme più moderne e minimali del corpo.

La collezione si sviluppa su una cartuccia dal diametro di 25mm, 35mm per le figure a incasso.

*In the ATELIER single-lever mixer collection, classically styled decorative details adorn the surfaces of the lever, base and aerator, creating a balance of absolute elegance with the more modern and minimalist shapes of the body.*

*The collection is developed on a 25mm diameter cartridge, 35mm for the built-in items.*



AVAILABLE  
FROM  
2024

**ATELIER**  
**OPZIONI DI FINITURA *FINISHING OPTIONS***





**DO** ORO LUCIDO  
*SHINY GOLD*

AT12DO

**CR**



cromo  
*chrome*

CR

**FIN 1**



nero opaco  
*matt black*

NO



bianco opaco  
*matt white*

BO



visual inox  
*visual steel*

XV

**FIN 2**



cromo nero spazzolato  
*brushed black chrome*

CFP



oro spazzolato  
*brushed gold*

BG



oro lucido  
*shiny gold*

DO



rame spazzolato  
*brushed copper*

RP



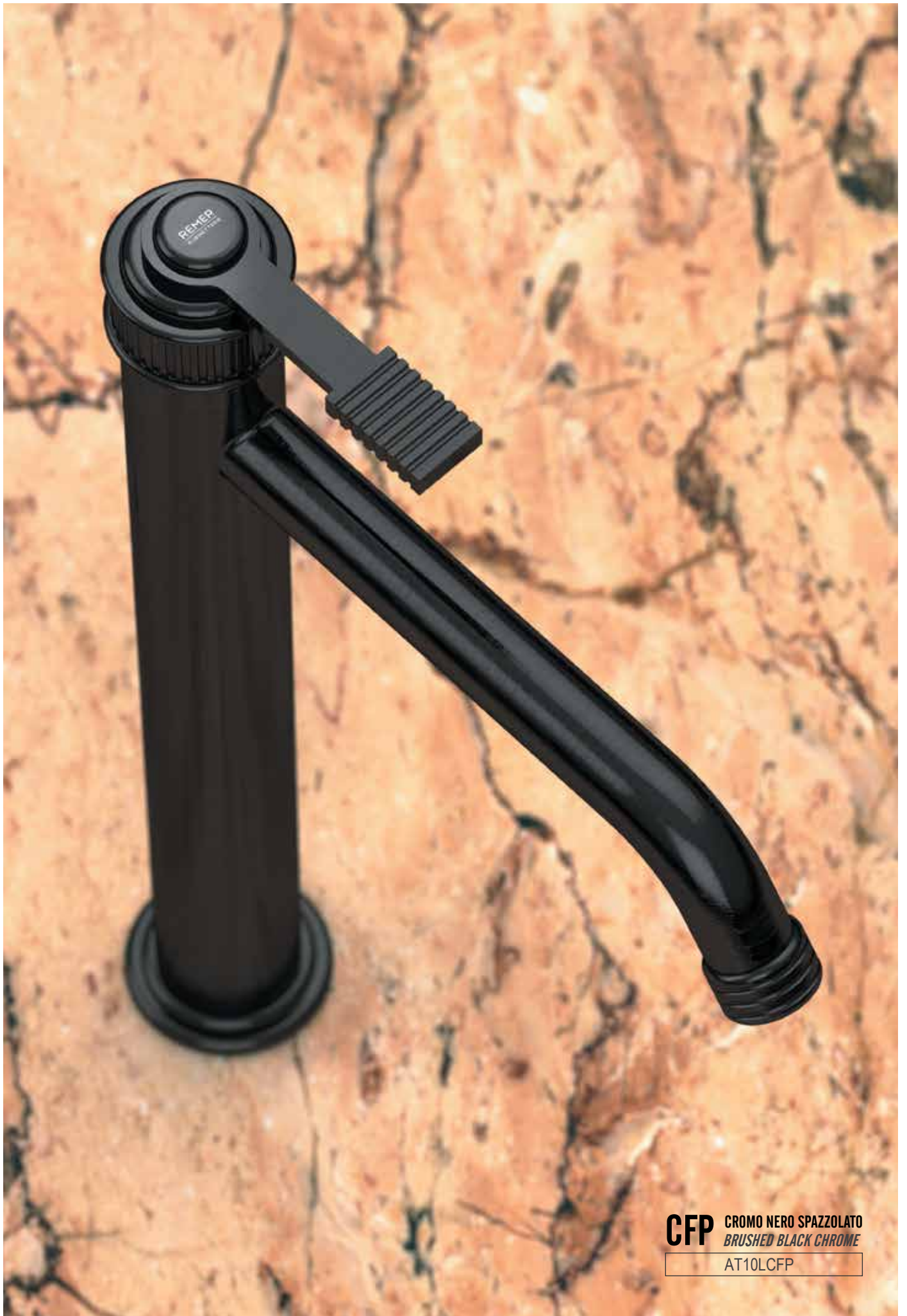

**CFP** CROMO NERO SPAZZOLATO  
*BRUSHED BLACK CHROME*  
AT10LCFP





**RP** RAME SPAZZOLATO  
BRUSHED COPPER  
AT53D2P

## MISCELATORI LAVABO - WASHBASIN MIXERS



### AL10

Miscelatore monocomando per lavabo, con scarico.

*Single-lever basin mixer, with pop-up waste.*



### AL10ACC

Miscelatore monocomando per lavabo, modello "A" altezza media, scarico click-clack con troppo-pieno incluso.

*Single-lever basin mixer, model "A" medium height, click-clack waste with overflow included.*



### AL10LXL

Miscelatore monocomando alto per lavabo, misura XL, scarico click-clack con troppo-pieno incluso.

*High single-lever washbasin mixer, XL size, click-clack waste with overflow included.*



### AL12

Miscelatore monocomando per lavabo, senza scarico e senza foro posteriore sul corpo.

*Single-lever basin mixer, without waste and without rear body hole.*



### AL12A

Miscelatore monocomando per lavabo, modello "A" altezza media, senza scarico e senza foro sul corpo.

*Single-lever basin mixer, model "A" medium height, without pop-up waste and with no rear hole.*



### AL11LXL

Miscelatore monocomando alto per lavabo, misura XL, scarico non incluso.

*High single-lever washbasin mixer, XL size, waste not included.*



### AL57

Miscelatore monocomando per lavabo a due fori. Scarico non incluso.

*2-hole single-lever basin mixer. Waste not included.*



### AL57L

Miscelatore monocomando per lavabo a due fori, con bocca L. Scarico non incluso.

*2-hole single-lever basin mixer, with L spout. Waste not included.*

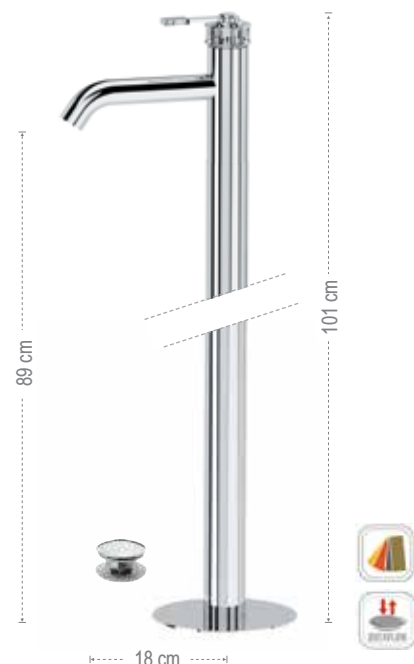

### AL18

Miscelatore monocomando da pavimento per lavabo, scarico click-clack con troppopieno incluso.

*Floor mounting single-lever basin mixer, click-clack waste with overflow included.*

MISCELATORI PER LAVABO A INCASSO - BUILT-IN WASHBASIN MIXER



**AL15**  
Miscelatore monocomando a incasso per lavabo. Piastra ultra-piatta. Lunghezza bocca 17 cm.  
*Single-lever built-it basin mixer. Ultra-flat flange. Spout length 17 cm.*



**AL15P**  
Miscelatore monocomando a incasso per lavabo, su due piastre tonde separate. Lunghezza bocca 17 cm.  
*Built-in single-lever basin mixer with two separate round plates. Spout length 17 cm.*

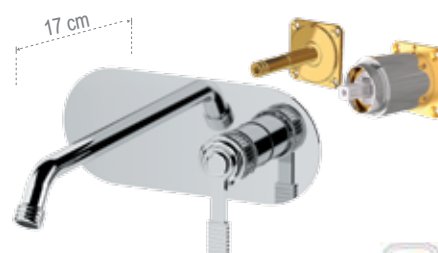

**AL15KB**  
Miscelatore monocomando a incasso per lavabo da abbinare al box incasso. Piastra ultra-piatta. Lunghezza bocca 17 cm.  
*Single-lever built-in basin mixer, with ultra-flat wall flange. To match with the built-in box. Spout length 17 cm.*



**AL15L**  
Miscelatore monocomando a incasso per lavabo. Piastra ultra-piatta. Lunghezza bocca 19 cm.  
*Single-lever built-it basin mixer. Ultra-flat flange. Spout length 19 cm.*



**AL15PL**  
Miscelatore monocomando a incasso per lavabo, su due piastre tonde separate. Lunghezza bocca 19 cm.  
*Built-in single-lever basin mixer with two separate round plates. Spout length 19 cm.*

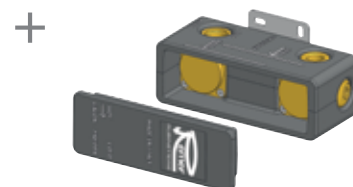

**RRBOX15**  
Box da incasso per miscelatore monocomando a incasso per lavabo.  
*Built-in box for single-lever built-in basin mixer.*

MISCELATORI PER BIDET - BIDET MIXERS



**AL20**  
Miscelatore monocomando per bidet, con scarico.  
*Single-lever bidet mixer, with pop-up waste.*



**AL22**  
Miscelatore monocomando per bidet, senza scarico e senza foro posteriore sul corpo.  
*Single-lever bidet mixer, without waste and without rear body hole.*



**AL65Z**  
Set shut-off comprensivo di: miscelatore a incasso con supporto doccia/presa acqua, doccetta a pulsante(332OZ), tutto in ottone. Flessibile doccia cm 120.  
*Shut-off set including: built-in mixer with shower holder/water punch on flange, shut-off hand shower (332OZ), all in brass. Flexible hose cm 120.*



**AL02**

Miscelatore monocomando per vasca, con kit doccia in ottone ad 1 funzione. Flessibile 150cm.  
*Wall mounted single-lever bath mixer with 1-function brass hand shower kit. 150cm flexible hose.*



**AL05**

Miscelatore monocomando per vasca, senza kit doccia.  
*Wall mounted single-lever bath mixer, without shower kit.*

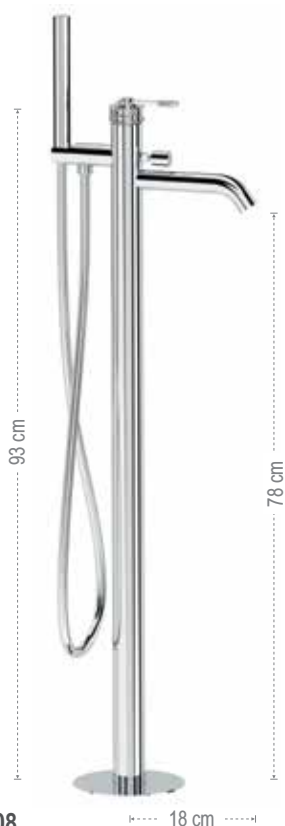

**AL08**

Miscelatore bordo vasca da pavimento, con deviatore e kit doccia in ottone.  
*Floor mounting single-lever bath mixer, with diverter and brass hand shower kit.*



AL08NO



2 VIE  
WAYS



**AL53D2P**

Set a incasso a 2 vie per vasca su piastre tonde separate ultra-piatte (3 piastre separate e incasso unico), include: miscelatore monocomando con deviatore a 2 uscite, bocca a muro; set doccia su piastra tonda ultra-piatta con presa acqua, supporto, doccetta e flessibile 150cm.

*2-way built-in set for bathtub on separate ultra-flat round plates (3 separate plates, one single built-in part), including: single-lever mixer, 2-way diverter, wall spout; Shower set on ultra-flat round plate with water connection, holder, hand shower and 150cm flexible hose.*



**AL53D2**

Set a incasso a 2 vie per vasca, include: miscelatore monocomando, deviatore a 2 uscite e bocca a muro su piastra unica rettangolare ultra-piatta; set doccia su piastra quadrata ultra-piatta con presa acqua, supporto integrato, doccetta in ottone e flessibile 150cm.

*2-way built-in set for bathtub, including: single-lever mixer, 2-way diverter and wall spout on a single ultra-flat rectangular plate; shower set on square ultra-flat plate with water connection, holder, brass handshower and 150cm flexible hose.*



**AL54D2P**

Set miscelatore a incasso a 2 vie per vasca/doccia su 3 piastre tonde ultra-piatte (piastre separate e incasso unico), include: miscelatore monocomando, deviatore a 2 uscite, bocca a muro. Da completare con la seconda uscita acqua.

*2-way built-in mixer set for bathtub / shower on 3 ultra-flat round plates (separate plates, one single built-in part), including: single-lever mixer, 2-way diverter, wall spout. To be completed with the second water outlet.*



**AL54D2**

Set miscelatore a incasso a 2 vie per vasca/doccia su piastra unica rettangolare ultra-piatta, include miscelatore monocomando, deviatore a 2 uscite, bocca a muro. Da completare con la seconda uscita.

*2-way built-in mixer set for bathtub / shower on single ultra-flat rectangular plate, including single-lever mixer, 2-way diverter, wall spout. To be completed with the second water outlet.*

3 VIE  
WAYS



**AL54D3P**

Set miscelatore a incasso a 3 vie per vasca/doccia su 3 piastre tonde ultra-piatte (piastre separate e incasso unico), include: miscelatore monocomando, deviatore a 3 uscite, bocca a muro. Da completare con la seconda e la terza uscita acqua.

*3-way built-in mixer set for bathtub / shower on 3 separate round plates (separate plates, one single built-in part), including: single-lever mixer, 3-way diverter, wall spout. To be completed with the second and the third water outlet.*

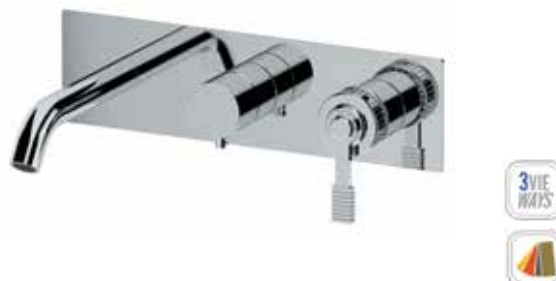

**AL54D3**

Set miscelatore a incasso a 3 vie per vasca/doccia su piastra unica rettangolare ultra-piatta, include miscelatore monocomando, deviatore a 3 uscite, bocca a muro. Da completare con la seconda e la terza uscita acqua.

*3-way built-in mixer set for bathtub / shower on single ultra-flat rectangular plate, including single-lever mixer, 3-way diverter, wall spout. To be completed with the second and the third water outlet.*

## INCASSI DOCCIA - BUILT-IN MIXERS

1 VIA WAY



### AL30L

Miscelatore a incasso per doccia, su piastra tonda ultra-piatta.  
*Built-in shower mixer, ultra-flat round wall flange.*



### AL30Q

Miscelatore a incasso per doccia, su piastra quadrata ultra-piatta.  
*Built-in shower mixer, ultra-flat square wall flange.*



2 VIE WAYS



### AL92ZP

Miscelatore a incasso per vasca/doccia con deviatore a 2 vie di tipo meccanico. Due piastre tonde ultra piatte. Parte a incasso unica, installazione orizzontale. Per selezionare l'uscita desiderata, posizionare la manopola del deviatore sulla posizione corrispondente.

*Built-in bath/shower mixer with 2-way mechanical diverter. Two ultra-flat round plates. Single built-in part, horizontal mounting. To select the desired water outlet, turn the diverter knob to the corresponding position.*



### AL92Z

Miscelatore a incasso per vasca/doccia con deviatore a 2 vie di tipo meccanico. Piastra rettangolare ultra piatta, installazione orizzontale. Per selezionare l'uscita desiderata, posizionare la manopola del deviatore sulla posizione corrispondente.

*Built-in bath/shower mixer with 2-way mechanical diverter. Ultra-flat rectangular plate, horizontal mounting. To select the desired water outlet, turn the diverter knob to the corresponding position.*





**AL97D2P**

Set miscelatore a incasso a 2 vie per vasca/doccia su 3 piastre tonde ultra-piatte (parte a incasso unica), include: miscelatore, deviatore a 2 uscite, presa acqua con supporto, doccetta in ottone e flessibile 150 cm. Da completare con la seconda uscita.

*2-way built-in shower mixer set on 3 ultra-flat round plates (1 single built-in part), including: mixer, 2-way diverter, water connection with holder, brass hand shower and 150cm flexible hose. To be completed with the second water outlet.*



**AL97D2**

Set miscelatore a incasso a 2 vie per vasca/doccia su piastra rettangolare ultra-piatta, include: miscelatore, deviatore a 2 uscite, presa acqua con supporto, doccetta in ottone e flessibile 150 cm. Da completare con la seconda uscita.

*2-way built-in shower mixer set on ultra-flat rectangular plate, including: mixer, 2-way diverter, water connection with holder, brass hand shower and 150cm flexible hose. To be completed with the second water outlet.*

**3 VIE WAYS**



**AL93ZP**

Miscelatore a incasso per vasca/doccia con deviatore a 3 vie di tipo meccanico. Due piastre tonde ultra piatte. Parte a incasso unica, installazione orizzontale. Per selezionare l'uscita desiderata, posizionare la manopola del deviatore sulla posizione corrispondente.

*Built-in bath/shower mixer with 3-way mechanical diverter. Two ultra-flat round plates. Single built-in part, horizontal mounting. To select the desired water outlet, turn the diverter knob to the corresponding position.*



**AL93Z**

Miscelatore a incasso per vasca/doccia con deviatore a 3 vie di tipo meccanico. Piastra rettangolare ultra piatta, installazione orizzontale. Per selezionare l'uscita desiderata, posizionare la manopola del deviatore sulla posizione corrispondente.

*Built-in bath/shower mixer with 3-way mechanical diverter. Ultra-flat rectangular plate, horizontal mounting. To select the desired water outlet, turn the diverter knob to the corresponding position.*



**AL97D3P**

Set miscelatore a incasso a 3 vie per vasca/doccia su 3 piastre tonde ultra-piatte (parte a incasso unica), include: miscelatore, deviatore a 3 uscite, presa acqua con supporto, doccetta in ottone e flessibile 150 cm. Da completare con la seconda e la terza uscita acqua.

*3-way built-in bath/shower mixer set on 3 ultra-flat round plates (1 single built-in part), including: mixer, 3-way diverter, water connection with holder, brass hand shower and 150cm flexible hose. To be completed with the second and the third water outlet.*



**AL97D3**

Set miscelatore a incasso a 3 vie per vasca/doccia su piastra rettangolare ultra-piatta, include: miscelatore, deviatore a 3 uscite, presa acqua con supporto, doccetta in ottone e flessibile 150 cm. Da completare con la seconda e la terza uscita acqua.

*3-way built-in shower mixer set on ultra-flat rectangular plate, including: mixer, 3-way diverter, water connection with holder, brass hand shower and 150cm flexible hose. To be completed with the second and the third water outlet.*

# ELEMENT





La collezione di rubinetteria ELEMENT esprime un'eleganza moderna data dall'essenzialità delle forme e dalla particolarità dell'impugnatura di miscelazione. Cartuccia a dischi ceramici Ø 35 mm.

*The ELEMENT faucet collection expresses a modern elegance given by the essentiality of the shapes and by the peculiarity of the mixing handle. Ceramic disc cartridge Ø 35 mm.*



**ELEMENT**  
**OPZIONI DI FINITURA** *FINISHING OPTIONS*



**BG** ORO SPAZZOLATO  
*BRUSHED GOLD*  
ET12BG



**NO** NERO OPACO  
MATT BLACK  
ET15PNO

**CR**



cromo  
chrome

CR

**FIN 1**



nero opaco  
matt black

NO



bianco opaco  
matt white

BO



nicel spazzolato  
brushed nickel

NP



visual inox  
visual steel

XV

**FIN 2**



cromo nero spazzolato  
brushed black chrome

CFP



oro spazzolato  
brushed gold

BG



oro lucido  
shiny gold

DO



rame spazzolato  
brushed copper

RP



**CFP** CROMO NERO SPAZZOLATO  
*BRUSHED BLACK CHROME*

ET57LCFP





**RP** RAME SPAZZOLATO  
BRUSHED COPPER  
ET18RP

## MISCELATORI LAVABO - WASHBASIN MIXERS



### ET10

Miscelatore monocomando per lavabo, con scarico.  
Single-lever basin mixer, with pop-up waste.



### ET10LXL

Miscelatore monocomando alto per lavabo, scarico click-clack con troppopieno incluso.  
High single-lever basin mixer, click-clack waste with overflow included.



### ET11LXL

Miscelatore monocomando alto per lavabo, senza scarico.  
High single-lever basin mixer, without waste.



### ET12

Miscelatore monocomando per lavabo, senza scarico e senza foro posteriore sul corpo.  
Single-lever basin mixer, without waste and without rear body hole.



### ET57

Miscelatore monocomando per lavabo a due fori. Scarico non incluso.  
2-hole single-lever basin mixer. Waste not included.



### ET57L

Miscelatore monocomando per lavabo a due fori, con bocca L. Scarico non incluso.  
2-hole single-lever basin mixer, with L spout. Waste not included.

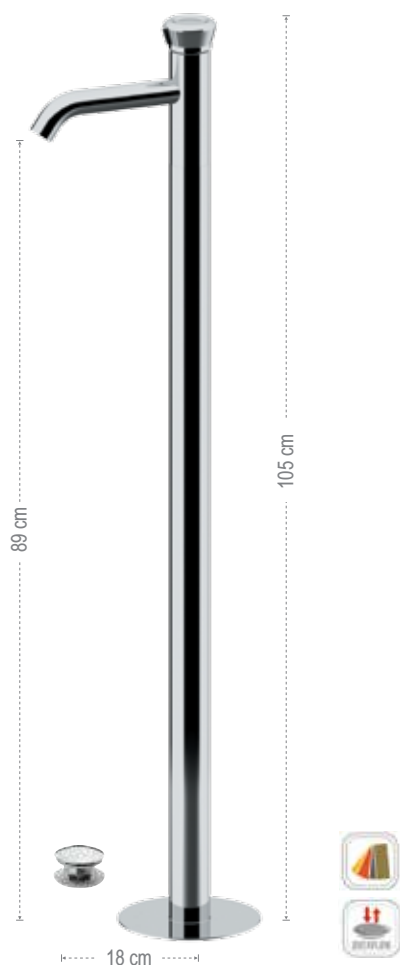

### ET18

Miscelatore monocomando da pavimento per lavabo, scarico click-clack con troppopieno incluso.  
Floor mounting single-lever basin mixer, click-clack waste with overflow included.

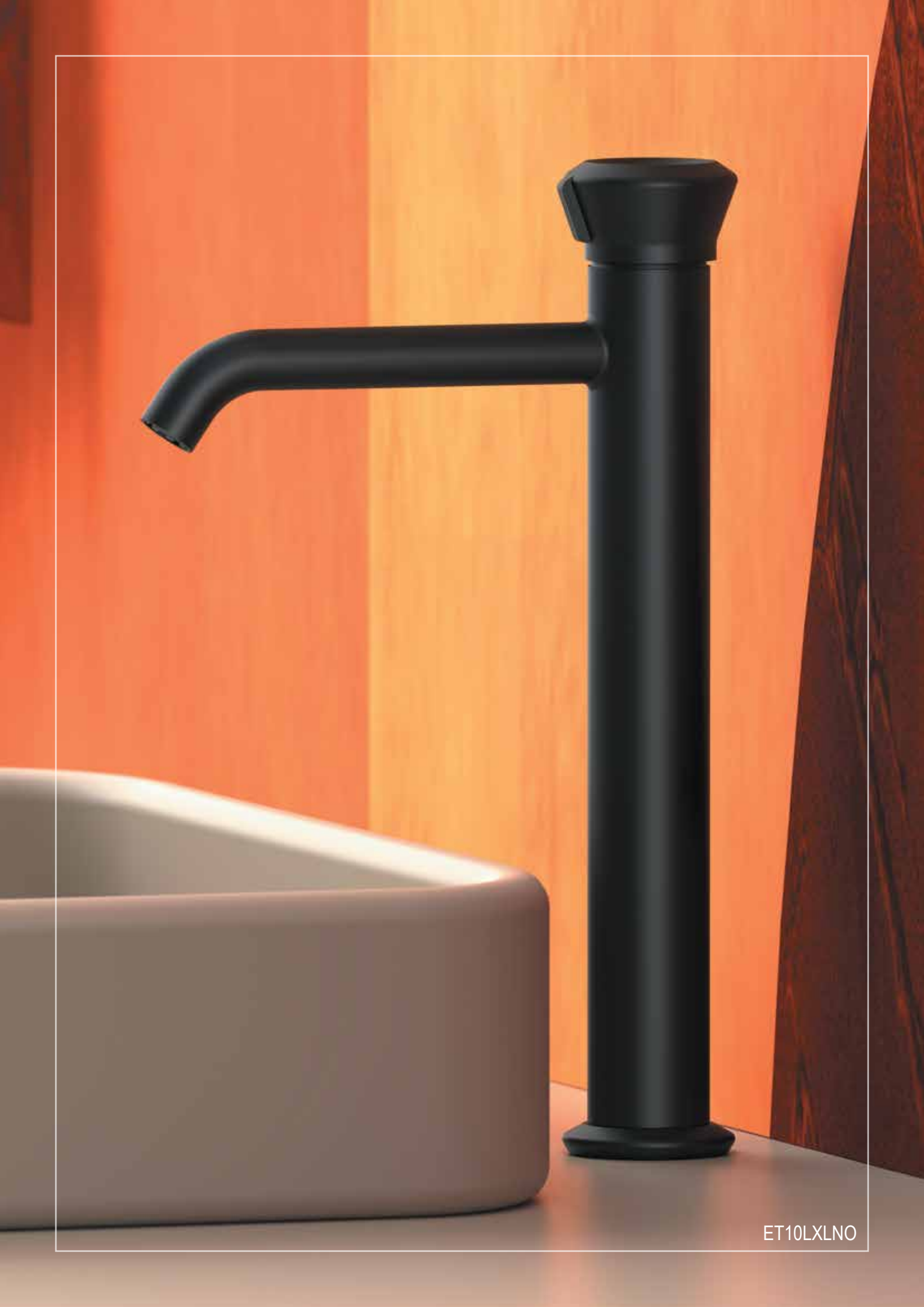

ET10LXLNO

## MISCELATORI PER LAVABO A INCASSO - BUILT-IN WASHBASIN MIXER

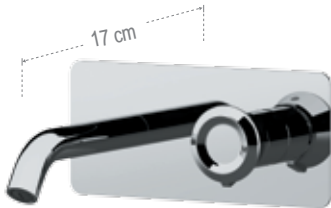

### ET15

Miscelatore monocomando a incasso per lavabo. Piastra ultra-piatta. Lunghezza bocca 17 cm

*Single-lever built-in basin mixer. Ultra-flat flange. Spout length 17 cm.*

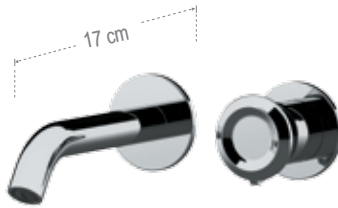

### ET15P

Miscelatore monocomando a incasso per lavabo, su due piastre tonde separate. Lunghezza bocca 17 cm.

*Built-in single-lever basin mixer with two separate round plates. Spout length 17 cm.*

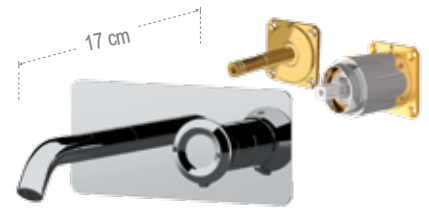

### ET15KB

Miscelatore monocomando a incasso per lavabo da abbinare al box incasso. Piastra ultra-piatta. Lunghezza bocca 17 cm.

*Single-lever built-in basin mixer, with ultra-flat wall flange. To match with the built-in box. Spout length 17 cm.*



+

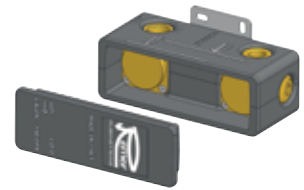

### RRBOX15

Box da incasso per miscelatore monocomando a incasso per lavabo.

*Built-in box for single-lever built-in basin mixer.*

## MISCELATORI PER BIDET - BIDET MIXERS



### ET20

Miscelatore monocomando per bidet, con scarico.

*Single-lever bidet mixer, with pop-up waste.*



### ET22

Miscelatore monocomando per bidet, senza scarico e senza foro posteriore sul corpo.

*Single-lever bidet mixer, without waste and without rear body hole.*



### ET65

Set shut-off comprensivo di: miscelatore a incasso con supporto doccia/presa acqua, doccetta a pulsante, tutto in ottone. Flessibile doccia cm 120.

*Shut-off set including: built-in mixer with shower holder/water punch on flange, shut-off hand shower, all in brass. Flexible hose cm 120.*





MISCELATORI PER VASCA E DOCCIA - SHOWER AND BATH MIXERS



**ET02**

Miscelatore monocomando per vasca, con kit doccia in ottone ad 1 funzione. Flessibile 150cm.

*Wall mounted single-lever bath mixer with 1-function brass hand shower kit. 150cm flexible hose.*



**ET05**

Miscelatore monocomando per vasca, senza kit doccia.

*Wall mounted single-lever bath mixer, without shower kit.*

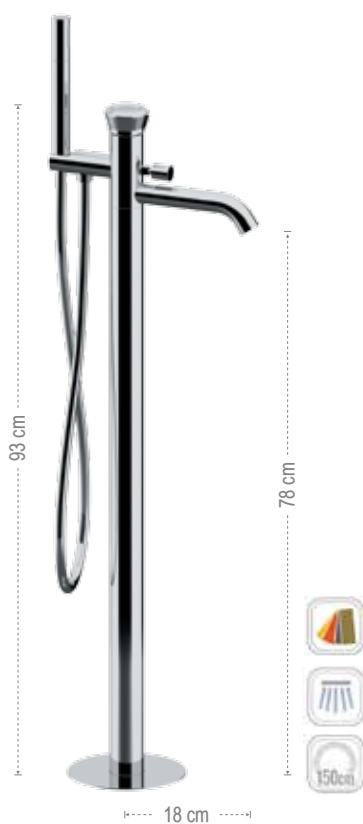

**ET08**

Miscelatore bordo vasca da pavimento, con deviatore e kit doccia in ottone.

*Floor mounting single-lever bath mixer, with diverter and brass hand shower kit.*



ET08CFP

2 VIE  
WAYS



#### ET53D2P

Set a incasso a 2 vie per vasca su piastre tonde separate ultra-piatte (3 piastre separate e incasso unico), include: miscelatore monocomando con deviatore a 2 uscite, bocca a muro; set doccia su piastra tonda ultra-piatta con presa acqua, supporto, doccetta e flessibile 150cm.

*2-way built-in set for bathtub on separate ultra-flat round plates (3 separate plates, one single built-in part), including: single-lever mixer, 2-way diverter, wall spout; Shower set on ultra-flat round plate with water connection, holder, hand shower and 150cm flexible hose.*



#### ET53D2

Set a incasso a 2 vie per vasca, include: miscelatore monocomando, deviatore a 2 uscite e bocca a muro su piastra unica rettangolare ultra-piatta; set doccia su piastra quadrata ultra-piatta con presa acqua, supporto integrato, doccetta in ottone e flessibile 150cm.

*2-way built-in set for bathtub, including: single-lever mixer, 2-way diverter and wall spout on a single ultra-flat rectangular plate; shower set on square ultra-flat plate with water connection, holder, brass handshower and 150cm flexible hose.*

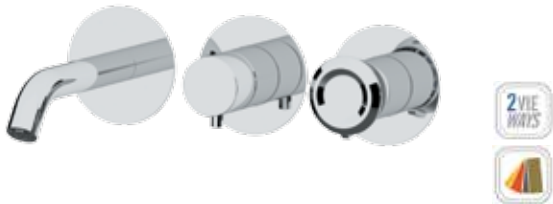

#### ET54D2P

Set miscelatore a incasso a 2 vie per vasca/doccia su 3 piastre tonde ultra-piatte (piastre separate e incasso unico), include: miscelatore monocomando, deviatore a 2 uscite, bocca a muro. Da completare con la seconda uscita acqua.

*2-way built-in mixer set for bathtub / shower on 3 ultra-flat round plates (separate plates, one single built-in part), including: single-lever mixer, 2-way diverter, wall spout. To be completed with the second water outlet.*

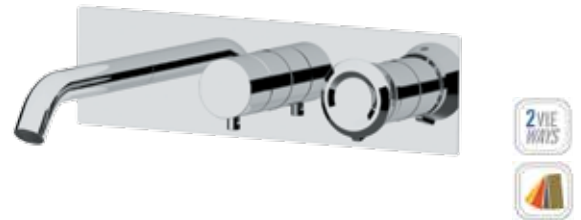

#### ET54D2

Set miscelatore a incasso a 2 vie per vasca/doccia su piastra unica rettangolare ultra-piatta, include miscelatore monocomando, deviatore a 2 uscite, bocca a muro. Da completare con la seconda uscita.

*2-way built-in mixer set for bathtub / shower on single ultra-flat rectangular plate, including single-lever mixer, 2-way diverter, wall spout. To be completed with the second water outlet.*

3 VIE  
WAYS

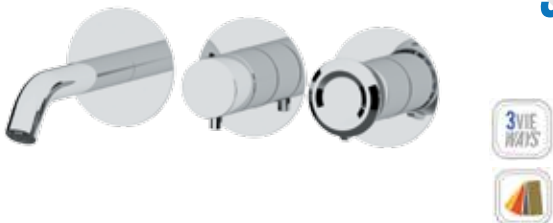

#### ET54D3P

Set miscelatore a incasso a 3 vie per vasca/doccia su 3 piastre tonde ultra-piatte (piastre separate e incasso unico), include: miscelatore monocomando, deviatore a 3 uscite, bocca a muro. Da completare con la seconda e la terza uscita acqua.

*3-way built-in mixer set for bathtub / shower on 3 separate round plates (separate plates, one single built-in part), including: single-lever mixer, 3-way diverter, wall spout. To be completed with the second and the third water outlet.*

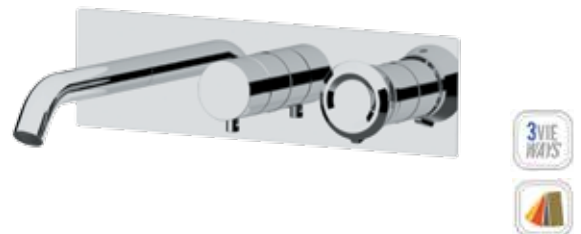

#### ET54D3

Set miscelatore a incasso a 3 vie per vasca/doccia su piastra unica rettangolare ultra-piatta, include miscelatore monocomando, deviatore a 3 uscite, bocca a muro. Da completare con la seconda e la terza uscita acqua.

*3-way built-in mixer set for bathtub / shower on single ultra-flat rectangular plate, including single-lever mixer, 3-way diverter, wall spout. To be completed with the second and the third water outlet.*

---

 INCASSI DOCCIA - BUILT-IN MIXERS
 

---

 1 VIA WAY
**ET30L**

Miscelatore a incasso per doccia, su piastra tonda ultra-piatta.  
*Built-in shower mixer, ultra-flat round wall flange.*

**ET30Q**

Miscelatore a incasso per doccia, su piastra quadrata ultra-piatta.  
*Built-in shower mixer, ultra-flat square wall flange.*



 2 VIE WAYS
**ET09L**

Miscelatore a incasso per vasca/doccia con deviatore a pressione, su piastra tonda ultra-piatta.  
*Built-in bath/shower mixer with push button diverter, on ultra-flat round wall flange.*

**ET09Q**

Miscelatore a incasso per vasca/doccia con deviatore a pressione, su piastra quadrata ultra-piatta.  
*Built-in bath/shower mixer with push button diverter, on ultra-flat square wall flange.*

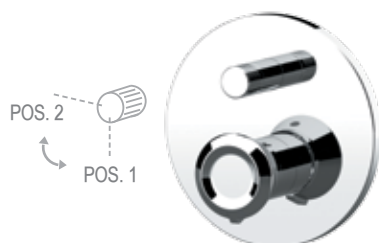
**ET09H**

Miscelatore a incasso per vasca/doccia con deviatore a 2 vie a vitone ceramico, su piastra tonda. Per selezionare l'uscita desiderata, la manopola del deviatore deve essere ruotata da una posizione all'altra.  
*Built-in bath/shower mixer with 2-way diverter with ceramic head valve, on round wall flange. To select the desired output, the diverter knob must be turned from one position to the other.*

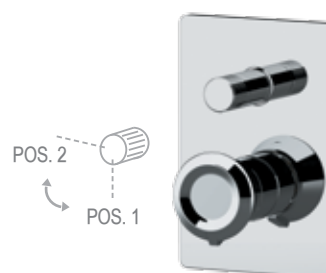
**ET09HG**

Miscelatore a incasso per vasca/doccia con deviatore a 2 vie a vitone ceramico, su piastra rettangolare. Per selezionare l'uscita desiderata, la manopola del deviatore deve essere ruotata da una posizione all'altra.  
*Built-in bath/shower mixer with 2-way diverter with ceramic head valve, on rectangular wall flange. To select the desired output, the diverter knob must be turned from one position to the other.*



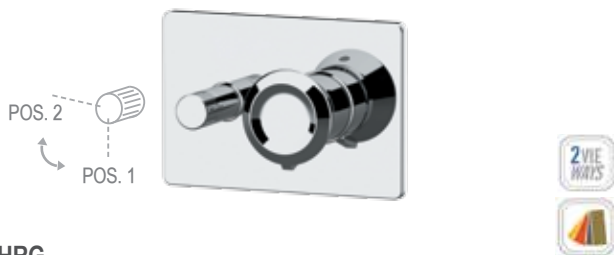

### ET09HRG

Miscelatore a incasso per vasca/doccia con deviatore a 2 vie con vitone ceramico, su piastra rettangolare, installazione orizzontale. Per selezionare l'uscita desiderata, la manopola del deviatore deve essere ruotata da una posizione all'altra.

*Built-in bath/shower mixer with 2-way diverter with ceramic head valve, on rectangular plate, horizontal mounting. To select the desired output, the diverter knob must be turned from one position to the other.*

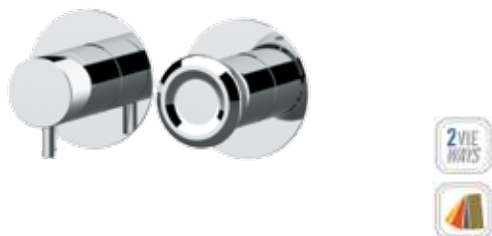

### ET92ZP

Miscelatore a incasso per vasca/doccia con deviatore a 2 vie di tipo meccanico. Due piastre tonde ultra piatte. Parte a incasso unica, installazione orizzontale. Per selezionare l'uscita desiderata, posizionare la manopola del deviatore sulla posizione corrispondente.

*Built-in bath/shower mixer with 2-way mechanical diverter. Two ultra-flat round plates. Single built-in part, horizontal mounting. To select the desired water outlet, turn the diverter knob to the corresponding position.*

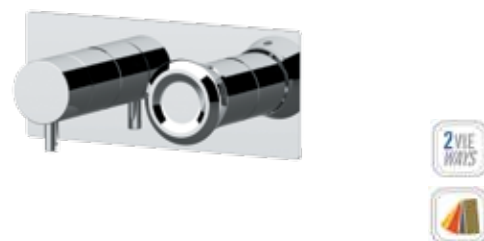

### ET92Z

Miscelatore a incasso per vasca/doccia con deviatore a 2 vie di tipo meccanico. Piastra rettangolare ultra piatta, installazione orizzontale. Per selezionare l'uscita desiderata, posizionare la manopola del deviatore sulla posizione corrispondente.

*Built-in bath/shower mixer with 2-way mechanical diverter. Ultra-flat rectangular plate, horizontal mounting. To select the desired water outlet, turn the diverter knob to the corresponding position.*



### ET97D2P

Set miscelatore a incasso a 2 vie per vasca/doccia su 3 piastre tonde ultra-piatte (parte a incasso unica), include: miscelatore, deviatore a 2 uscite, presa acqua con supporto, doccetta in ottone e flessibile 150 cm. Da completare con la seconda uscita.

*2-way built-in shower mixer set on 3 ultra-flat round plates (1 single built-in part), including: mixer, 2-way diverter, water connection with holder, brass hand shower and 150cm flexible hose. To be completed with the second water outlet.*



### ET97D2

Set miscelatore a incasso a 2 vie per vasca/doccia su piastra rettangolare ultra-piatta, include: miscelatore, deviatore a 2 uscite, presa acqua con supporto, doccetta in ottone e flessibile 150 cm. Da completare con la seconda uscita.

*2-way built-in shower mixer set on ultra-flat rectangular plate, including: mixer, 2-way diverter, water connection with holder, brass hand shower and 150cm flexible hose. To be completed with the second water outlet.*



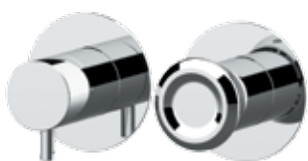

**ET93ZP**

Miscelatore a incasso per vasca/doccia con deviatore a 2 vie di tipo meccanico. Due piastre tonde ultra piatte. Parte a incasso unica, installazione orizzontale. Per selezionare l'uscita desiderata, posizionare la manopola del deviatore sulla posizione corrispondente.

*Built-in bath/shower mixer with 2-way mechanical diverter. Two ultra-flat round plates. Single built-in part, horizontal mounting. To select the desired water outlet, turn the diverter knob to the corresponding position.*

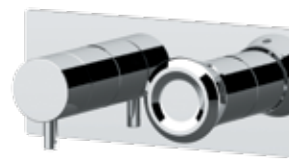

**ET93Z**

Miscelatore a incasso per vasca/doccia con deviatore a 3 vie di tipo meccanico. Piastra rettangolare ultra piatta, installazione orizzontale. Per selezionare l'uscita desiderata, posizionare la manopola del deviatore sulla posizione corrispondente.

*Built-in bath/shower mixer with 3-way mechanical diverter. Ultra-flat rectangular plate, horizontal mounting. To select the desired water outlet, turn the diverter knob to the corresponding position.*



**ET97D3P**

Set miscelatore a incasso a 3 vie per vasca/doccia su 3 piastre tonde ultra-piatte (parte a incasso unica), include: miscelatore, deviatore a 3 uscite, presa acqua con supporto, doccetta in ottone e flessibile 150 cm. Da completare con la seconda e la terza uscita acqua.

*3-way built-in bath/shower mixer set on 3 ultra-flat round plates (1 single built-in part), including: mixer, 3-way diverter, water connection with holder, brass hand shower and 150cm flexible hose. To be completed with the second and the third water outlet.*



**ET97D3**

Set miscelatore a incasso a 3 vie per vasca/doccia su piastra rettangolare ultra-piatta, include: miscelatore, deviatore a 3 uscite, presa acqua con supporto, doccetta in ottone e flessibile 150 cm. Da completare con la seconda e la terza uscita acqua.

*3-way built-in shower mixer set on ultra-flat rectangular plate, including: mixer, 3-way diverter, water connection with holder, brass hand shower and 150cm flexible hose. To be completed with the second and the third water outlet.*

# SLASH & DOT



Le collezioni SLASH & DOT sono due soluzioni complete di rubinetteria per bagno e cucina che condividono un design moderno e compatto. Il corpo tondo del miscelatore si sviluppa su una cartuccia diametro 35mm e si collega tramite una morbida curvatura ad una bocca dalle superfici piate e dai bordi smussati.

*The SLASH & DOT collections are two complete faucet solutions for bathroom and kitchen that share a modern and compact design. The round body of the mixer is developed on a 35mm diameter cartridge and is connected by a soft curvature to a spout with flat surfaces and rounded edges.*



**SLASH&DOT**  
**OPZIONE LEVA *LEVER OPTION***

LEVA / *LEVER*  
**DOT**



LEVA / *LEVER*  
**SLASH**







**BO** BIANCO OPACO  
MATT WHITE  
SL15BO

**SLASH&DOT**  
**OPZIONI DI FINITURA *FINISHING OPTIONS***



**CFP** CROMO NERO SPAZZOLATO  
*BRUSHED BLACK CHROME*

SL12CFP



**RP** RAME SPAZZOLATO  
BRUSHED COPPER

SL10LRP

**CR**



cromo  
chrome

CR

**FIN 1**



nero opaco  
matt black

NO



bianco opaco  
matt white

BO



nicel spazzolato  
brushed nickel

NP



visual inox  
visual steel

XV

**FIN 2**



cromo nero spazzolato  
brushed black chrome

CFP



oro spazzolato  
brushed gold

BG



oro lucido  
shiny gold

DO



rame spazzolato  
brushed copper

RP

La collezione è disponibile con due varianti di maniglia, identificate dalle prime due lettere del codice prodotto. Indicare la preferenza al momento dell'ordine.

This collection is available with two lever options, identified by the first two letters of the product code. Show your preference when ordering.

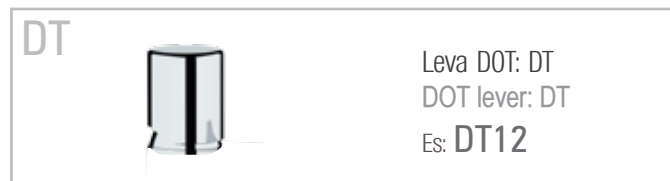

## MISCELATORI LAVABO - WASHBASIN MIXERS



**SL10**  
Miscelatore monocomando per lavabo, con scarico.  
*Single-lever basin mixer, with pop-up waste.*



**SL10L**  
Miscelatore monocomando alto per lavabo, scarico click-clack con troppopieno incluso.  
*High single-lever basin mixer, click-clack waste with overflow included.*



**SL57**  
Miscelatore monocomando per lavabo a due fori. Scarico non incluso.  
*2-hole single-lever basin mixer. Waste not included.*



**SL12**  
Miscelatore monocomando per lavabo, senza scarico e senza foro posteriore sul corpo.  
*Single-lever basin mixer, without waste and without rear body hole.*



**SL11L**  
Miscelatore monocomando alto per lavabo, senza scarico.  
*High single-lever basin mixer, without waste.*



**SL57L**  
Miscelatore monocomando per lavabo a due fori, con bocca L. Scarico non incluso.  
*2-hole single-lever basin mixer, with L spout. Waste not included.*



MISCELATORI PER LAVABO A INCASSO - BUILT-IN WASHBASIN MIXER

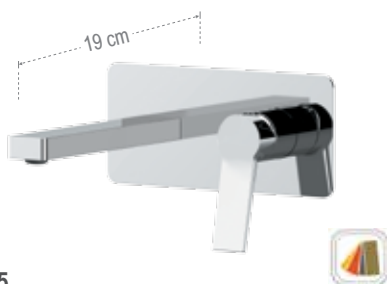

**SL15**  
 Miscelatore monocomando a incasso per lavabo. Piastra ultra-piatta. Lunghezza bocca 19 cm.  
*Single-lever built-in basin mixer. Ultra-flat flange. Spout length 19 cm.*

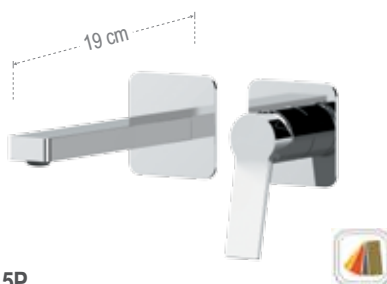

**SL15P**  
 Miscelatore monocomando a incasso per lavabo, su due piastre tonde separate. Lunghezza bocca 19 cm.  
*Built-in single-lever basin mixer with two separate round plates. Spout length 19 cm.*

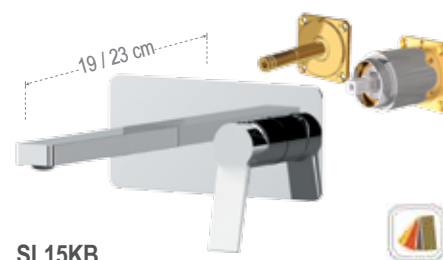

**SL15KB**  
 Miscelatore monocomando a incasso per lavabo da abbinare al box incasso. Piastra ultra-piatta. Lunghezza bocca 19 cm.  
*Single-lever built-in basin mixer, with ultra-flat wall flange. To match with the built-in box. Spout length 19 cm.*

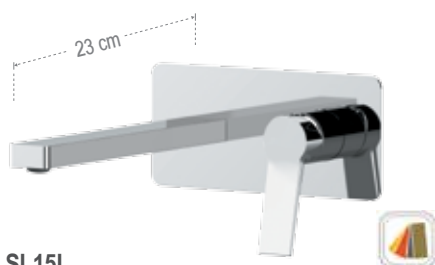

**SL15L**  
 Miscelatore monocomando a incasso per lavabo. Piastra ultra-piatta. Lunghezza bocca 23 cm.  
*Single-lever built-in basin mixer. Ultra-flat flange. Spout length 23 cm.*

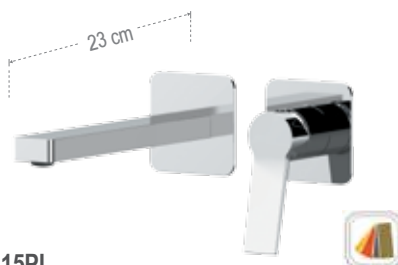

**SL15PL**  
 Miscelatore monocomando a incasso per lavabo, su due piastre tonde separate. Lunghezza bocca 23 cm.  
*Built-in single-lever basin mixer with two separate round plates. Spout length 23 cm.*

**SL15LKB**  
 Lunghezza bocca 23cm.  
*Spout length 23cm.*

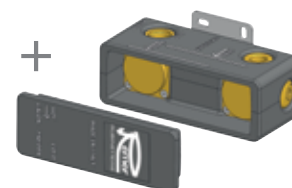

**RRBOX15**  
 Box da incasso per miscelatore monocomando a incasso per lavabo.  
*Built-in box for single-lever built-in basin mixer.*

MISCELATORI PER BIDET - BIDET MIXERS



**SL20**  
 Miscelatore monocomando per bidet, con scarico.  
*Single-lever bidet mixer, with pop-up waste.*



**SL22**  
 Miscelatore monocomando per bidet, senza scarico e senza foro posteriore sul corpo.  
*Single-lever bidet mixer, without waste and without rear body hole.*



**SL65W**  
 Set shut-off comprensivo di: miscelatore a incasso con supporto doccia/presa acqua, doccetta a pulsante 332OW, tutto in ottone. Flessibile doccia cm 120.  
*Shut-off set including: built-in mixer with shower holder/water punch on flange, shut-off hand shower 332OW, all in brass. Flexible hose cm 120.*

## MISCELATORI PER VASCA E DOCCIA - SHOWER AND BATH MIXERS



### SL02

Miscelatore monocomando per vasca, doccetta a 3 funzioni in abs con pulsante per la selezione dei getti, supporto a muro snodato. Flessibile 150cm.

*Single-lever bath mixer, 3-function handshower in abs with jet selection button, wall adjustable shower holder. Flexible 150cm, jointed wall bracket. Flexible hose 150cm.*



### SLC31REW

Miscelatore monocomando esterno per doccia, interasse 100 mm, con doccetta shut-off e flessibile cm 120.

*Wall mounted single lever shower mixer, interaxis 100 mm, including shut-off and flexible hose cm 120.*



### SL38

Miscelatore doccia con leva frontale, doccetta a 3 funzioni in abs con pulsante per la selezione dei getti, supporto doccetta a muro. Flessibile 150cm.

*Exposed shower mixer with frontal lever, 3-function handshower in abs with jet selection button, wall shower holder. Flexible hose 150cm.*

### SL05

Miscelatore monocomando per vasca con deviatore, senza kit doccia.

*Wall mounted single-lever bath mixer with diverter, without shower kit.*

### SLC31

Miscelatore monocomando esterno per doccia, interasse 100 mm, senza kit doccia.

*Wall mounted single lever shower mixer, interaxis 100 mm, without shower kit.*

### SL33

Miscelatore doccia con leva frontale, senza kit doccia.

*Exposed shower mixer with frontal lever, without shower kit.*

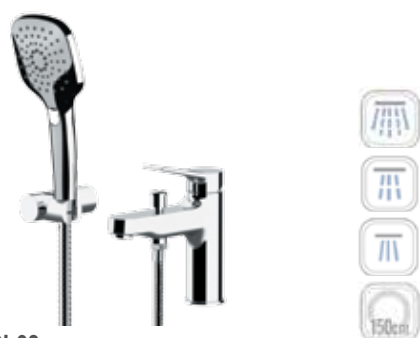

### SL03

Miscelatore monocomando da appoggio per vasca, con deviatore, doccetta a 3 funzioni in abs con pulsante per la selezione dei getti, supporto a muro snodato. Flessibile 150cm.

*Single lever bath mixer with diverter, 3-function handshower in abs with jet selection button, adjustable wall shower holder. Flexible hose 150cm.*



### SL04

Miscelatore monocomando per vasca, con deviatore, senza kit doccia.

*Single lever bath mixer with diverter, without shower kit.*

## BOCCHE - SPOUT

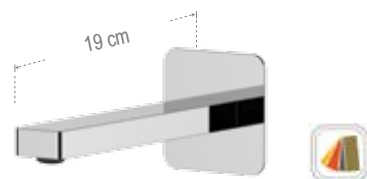

### 91SL

Bocca a incasso. Lunghezza bocca: 19 cm.

*Built-in spout. Spout length: 19 cm*

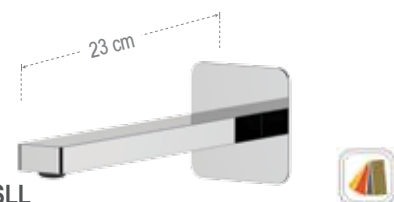

### 91SLL

Bocca a incasso. Lunghezza bocca: 23 cm.

*Built-in spout. Spout length: 23 cm*

2 VIE  
WAYS



**SL53D2P**

Set a incasso a 2 vie per vasca su piastre tonde separate ultra-piatte (3 piastre separate e incasso unico), include: miscelatore monocomando con deviatore a 2 uscite, bocca a muro; set doccia su piastra tonda ultra-piatta con presa acqua, supporto, doccetta e flessibile 150cm.  
 2-way built-in set for bathtub on separate ultra-flat round plates (3 separate plates, one single built-in part), including: single-lever mixer, 2-way diverter, wall spout; Shower set on ultra-flat round plate with water connection, holder, hand shower and 150cm flexible hose.



**SL53D2**

Set a incasso a 2 vie per vasca, include: miscelatore monocomando, deviatore a 2 uscite e bocca a muro su piastra unica rettangolare ultra-piatta; set doccia su piastra quadrata ultra-piatta con presa acqua, supporto integrato, doccetta in ottone e flessibile 150cm.  
 2-way built-in set for bathtub, including: single-lever mixer, 2-way diverter and wall spout on a single ultra-flat rectangular plate; shower set on square ultra-flat plate with water connection, holder, brass handshower and 150cm flexible hose.

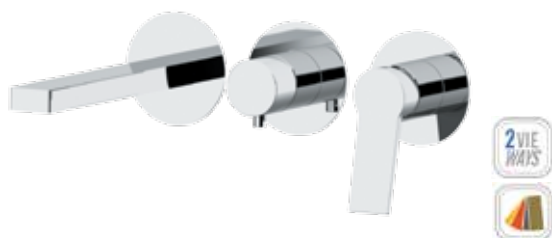

**SL54D2P**

Set miscelatore a incasso a 2 vie per vasca/doccia su 3 piastre tonde ultra-piatte (piastre separate e incasso unico), include: miscelatore monocomando, deviatore a 2 uscite, bocca a muro. Da completare con la seconda uscita acqua.  
 2-way built-in mixer set for bathtub / shower on 3 ultra-flat round plates (separate plates, one single built-in part), including: single-lever mixer, 2-way diverter, wall spout. To be completed with the second water outlet.

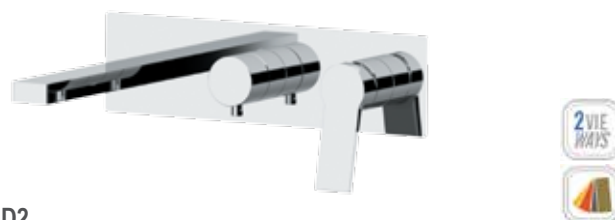

**SL54D2**

Set miscelatore a incasso a 2 vie per vasca/doccia su piastra unica rettangolare ultra-piatta, include miscelatore monocomando, deviatore a 2 uscite, bocca a muro. Da completare con la seconda uscita.  
 2-way built-in mixer set for bathtub / shower on single ultra-flat rectangular plate, including single-lever mixer, 2-way diverter, wall spout. To be completed with the second water outlet.

3 VIE  
WAYS

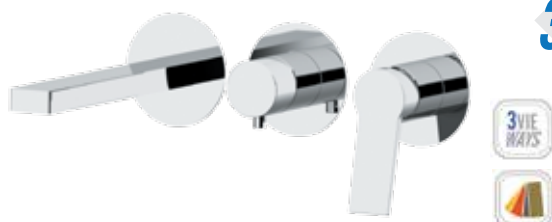

**SL54D3P**

Set miscelatore a incasso a 3 vie per vasca/doccia su 3 piastre tonde ultra-piatte (piastre separate e incasso unico), include: miscelatore monocomando, deviatore a 3 uscite, bocca a muro. Da completare con la seconda e la terza uscita acqua.  
 3-way built-in mixer set for bathtub / shower on 3 separate round plates (separate plates, one single built-in part), including: single-lever mixer, 3-way diverter, wall spout. To be completed with the second and the third water outlet.

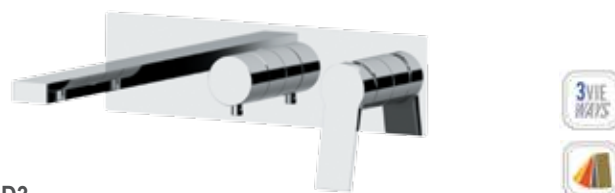

**SL54D3**

Set miscelatore a incasso a 3 vie per vasca/doccia su piastra unica rettangolare ultra-piatta, include miscelatore monocomando, deviatore a 3 uscite, bocca a muro. Da completare con la seconda e la terza uscita acqua.  
 3-way built-in mixer set for bathtub / shower on single ultra-flat rectangular plate, including single-lever mixer, 3-way diverter, wall spout. To be completed with the second and the third water outlet.





MISCELATORI AD INCASSO PER DOCCIA - BUILT-IN SHOWER MIXERS



1 VIA WAY



**SL30**  
Miscelatore incasso per doccia su piastra tonda.  
*Built-in shower mixer on round plate.*



**SL30G**  
Miscelatore incasso per doccia su piastra rettangolare.  
*Built-in shower mixer on rectangular flange.*



**SL30L**  
Miscelatore incasso per doccia su piastra lusso ultrapiatta.  
*Built-in shower mixer on luxury ultraslim plate.*



2 VIE WAYS



**SL09**  
Miscelatore incasso con deviatore a pressione per vasca/doccia su piastra tonda.  
*Built-in bath/shower mixer with push button diverter on round plate.*



**SL09G**  
Miscelatore incasso con deviatore a pressione per vasca/doccia su piastra rettangolare.  
*Built-in bath/shower mixer with push button diverter on rectangular plate.*



**SL09L**  
Miscelatore incasso con deviatore a pressione per vasca/doccia su piastra rettangolare ultra piatta.  
*Built-in bath/shower mixer with push button diverter on ultra-flat rectangular plate.*

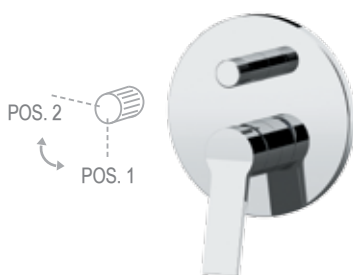

**SL09H**  
Miscelatore a incasso per vasca/doccia con deviatore a 2 vie a vitone ceramico, su piastra tonda. Per selezionare l'uscita desiderata, la manopola del deviatore deve essere ruotata da una posizione all'altra.  
*Built-in bath/shower mixer with 2-way diverter with ceramic head valve, on round wall flange. To select the desired output, the diverter knob must be turned from one position to the other.*

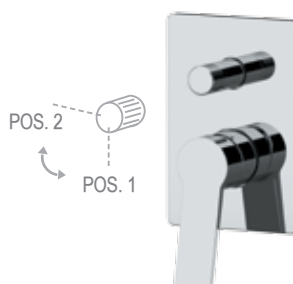

**SL09HG**  
Miscelatore a incasso per vasca/doccia con deviatore a 2 vie a vitone ceramico, su piastra rettangolare. Per selezionare l'uscita desiderata, la manopola del deviatore deve essere ruotata da una posizione all'altra.  
*Built-in bath/shower mixer with 2-way diverter with ceramic head valve, on rectangular wall flange. To select the desired output, the diverter knob must be turned from one position to the other.*

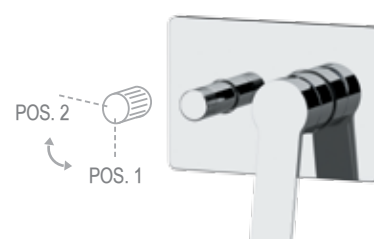

**SL09HRG**  
Miscelatore a incasso per vasca/doccia con deviatore a 2 vie con vitone ceramico, su piastra rettangolare, installazione orizzontale. Per selezionare l'uscita desiderata, la manopola del deviatore deve essere ruotata da una posizione all'altra.  
*Built-in bath/shower mixer with 2-way diverter with ceramic head valve, on rectangular plate, horizontal mounting. To select the desired output, the diverter knob must be turned from one position to the other.*



### SL92ZP

Miscelatore a incasso per vasca/doccia con deviatore a 2 vie di tipo meccanico. Due piastre tonde ultra piatte. Parte a incasso unica, installazione orizzontale. Per selezionare l'uscita desiderata, posizionare la manopola del deviatore sulla posizione corrispondente.

*Built-in bath/shower mixer with 2-way mechanical diverter. Two ultra-flat round plates. Single built-in part, horizontal mounting. To select the desired water outlet, turn the diverter knob to the corresponding position.*

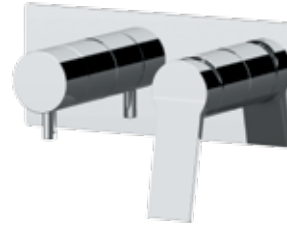

### SL92Z

Miscelatore a incasso per vasca/doccia con deviatore a 2 vie di tipo meccanico. Piastra rettangolare ultra piatta, installazione orizzontale. Per selezionare l'uscita desiderata, posizionare la manopola del deviatore sulla posizione corrispondente.

*Built-in bath/shower mixer with 2-way mechanical diverter. Ultra-flat rectangular plate, horizontal mounting. To select the desired water outlet, turn the diverter knob to the corresponding position.*



### SL97D2P

Set miscelatore a incasso a 2 vie per vasca/doccia su 3 piastre tonde ultra-piatte (parte a incasso unica), include: miscelatore, deviatore a 2 uscite, presa acqua con supporto, doccia in ottone e flessibile 150 cm. Da completare con la seconda uscita.

*2-way built-in shower mixer set on 3 ultra-flat round plates (1 single built-in part), including: mixer, 2-way diverter, water connection with holder, brass hand shower and 150cm flexible hose. To be completed with the second water outlet.*



### SL97D2

Set miscelatore a incasso a 2 vie per vasca/doccia su piastra rettangolare ultra-piatta, include: miscelatore, deviatore a 2 uscite, presa acqua con supporto, doccia in ottone e flessibile 150 cm. Da completare con la seconda uscita.

*2-way built-in shower mixer set on ultra-flat rectangular plate, including: mixer, 2-way diverter, water connection with holder, brass hand shower and 150cm flexible hose. To be completed with the second water outlet.*



SL97D2PXV

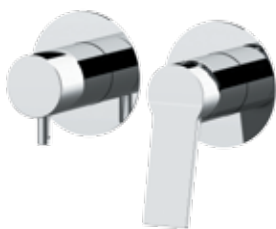

3 VIE  
WAYS



### SL93ZP

Miscelatore a incasso per vasca o doccia con deviatore a 3 vie di tipo meccanico. Piastre tonde separate ultra piatte. Parte a incasso unica per installazione in orizzontale. Per selezionare l'uscita desiderata, posizionare la manopola del deviatore sulla posizione corrispondente.

*Built-in mixer for bath and shower with 3-way mechanical diverter. Separate ultra-flat round plates. Single built-in part for horizontal mounting. To select the desired water outlet, turn the diverter knob to the corresponding position.*

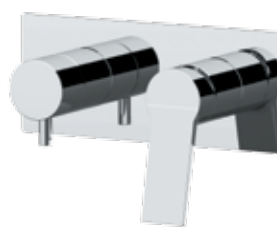

### SL93Z

Miscelatore a incasso per vasca e doccia con deviatore a 3 vie di tipo meccanico. Piastra rettangolare ultra piatta per installazione in orizzontale. Per selezionare l'uscita desiderata, posizionare la manopola del deviatore sulla posizione corrispondente.

*Built-in mixer for bath and shower with 3-way mechanical diverter. Ultra flat rectangular plate for horizontal mounting. To select the desired water outlet, turn the diverter knob to the corresponding position.*



### SL97D3P

Set miscelatore a incasso a 3 vie per vasca/doccia su 3 piastre tonde ultra-piatte (parte a incasso unica), include: miscelatore, deviatore a 3 uscite, presa acqua con supporto, doccetta in ottone e flessibile 150 cm. Da completare con la seconda e la terza uscita acqua.

*3-way built-in bath/shower mixer set on 3 ultra-flat round plates (1 single built-in part), including: mixer, 3-way diverter, water connection with holder, brass hand shower and 150cm flexible hose. To be completed with the second and the third water outlet.*

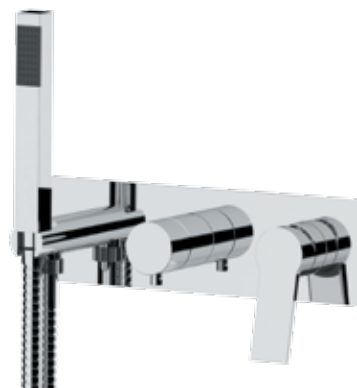

### SL97D3

Set miscelatore a incasso a 3 vie per vasca/doccia su piastra rettangolare ultra-piatta, include: miscelatore, deviatore a 3 uscite, presa acqua con supporto, doccetta in ottone e flessibile 150 cm. Da completare con la seconda e la terza uscita acqua.

*3-way built-in shower mixer set on ultra-flat rectangular plate, including: mixer, 3-way diverter, water connection with holder, brass hand shower and 150cm flexible hose. To be completed with the second and the third water outlet.*



4/5 VIE  
WAYS



### SL94

Miscelatore incasso con deviatore a 4 vie per vasca/doccia , 1 entrata e 4 uscite.

*Built-in bath/shower mixer with 4-way diverter, 1 inlet and 4 outlets.*



### SL95

Miscelatore incasso con deviatore a 5 vie per vasca/doccia , 1 entrata e 5 uscite.

*Built-in bath/shower mixer with 5-way diverter, 1 inlet and 5 outlets.*



CUCINA - KITCHEN



**SL84**  
Miscelatore monocomando per lavello, con canna alta girevole e sistema di doccetta monofunzione estraibile.  
*Single-lever sink mixer with high swivel spout and single-function system pull-out hand shower.*



**SL84DJ**  
Miscelatore monocomando per lavello, con canna alta girevole e doccetta estraibile a due funzioni.  
*Single-lever sink mixer with high swivel spout and 2-functions pull-out hand shower.*



**SL81M**  
Miscelatore monocomando per lavello, con canna alta girevole e doccetta estraibile con impugnatura a martello a due funzioni.  
*Single-lever sink mixer with high swivel spout and 2-functions pull-out "hammer shaped" handle hand shower.*



**SL42B**  
Miscelatore monocomando per lavello, con bocca alta girevole.  
*Single-lever one-hole sink mixer, with high swivel spout.*



**SL72Q**  
Miscelatore monocomando per lavello, con bocca alta girevole squadrata.  
*Single lever kitchen mixer with high swivel squared spout*



**SL72U**  
Miscelatore monocomando monoforo 90°, con canna alta girevole a "U".  
*Single-lever sink mixer 90°, high swivel "U" spout.*



**SL72**  
Miscelatore monocomando per lavello, con bocca alta girevole.  
*Single-lever one-hole sink mixer, with high swivel spout.*



**SL72C**  
Miscelatore monocomando lavabo/lavello senza scarico, con canna corta girevole, tipo lusso.  
*Single-lever basin/sink mixer without waste, with short swivel spout, luxury type.*

# IN PERFETTA SINTONIA

# YOUR PERFECT TUNE

Ogni prodotto Remer Rubinetterie è attentamente studiato per darvi il massimo del comfort, puntando alla perfetta sintonia con voi, i vostri arredi e le vostre abitudini di utilizzo.

Oltre all'ampiezza di gamma che ci contraddistingue, le nostre collezioni di rubinetteria sono in continuo aggiornamento per rispondere ad esigenze di arredo sempre nuove.

Per questo motivo le nostre collezioni più vendute accolgono ora i modelli di miscelatori per lavabo ad altezza media che si aggiungono alle misure già disponibili.

*Each Remer Rubinetterie product is carefully designed to give you maximum comfort, aiming for perfect tuning with you, your furnishings and your usage habits.*

*In addition to the width of the range that sets us apart, our tapware collections are constantly being updated to meet ever-changing furnishing needs.*

*This is why our best-selling collections now include medium height basin mixer models in addition to the sizes already available.*



## ABSOLUTE



## ENERGY



## CLASS LINE



### AU10ACC

Miscelatore monocomando per lavabo, modello "A" altezza media, scarico click-clack con troppopieno incluso.

*Single-lever basin mixer, model "A" medium height, click-clack waste with overflow included.*



### EY10ACC

Miscelatore monocomando per lavabo, modello "A" altezza media, scarico click-clack con troppopieno incluso.

*Single-lever basin mixer, model "A" medium height, click-clack waste with overflow included.*



### L10LACC

Miscelatore monocomando per lavabo, modello "A" altezza media, scarico click-clack con troppopieno incluso.

*Single-lever basin mixer, model "A" medium height, click-clack waste with overflow included.*



### AU12A

Miscelatore monocomando per lavabo, modello "A" altezza media, senza scarico e senza foro sul corpo.

*Single-lever basin mixer, model "A" medium height, without pop-up waste and with no rear hole.*



### EY12A

Miscelatore monocomando per lavabo, modello "A" altezza media, senza scarico e senza foro sul corpo.

*Single-lever basin mixer, model "A" medium height, without pop-up waste and with no rear hole.*



### L12LA

Miscelatore monocomando per lavabo, modello "A" altezza media, senza scarico e senza foro sul corpo.

*Single-lever basin mixer, model "A" medium height, without pop-up waste and with no rear hole.*

# NEWS WELLNESS WELLNESS NEWS



**MISCELATORI A INCASSO  
BUILT-IN MIXERS**  
100



**SOFFIONI  
SHOWER HEAD**  
118





122 SHUT-OFF

## NUOVI MISCELATORI A INCASSO PER VASCA E DOCCIA NEW BUILT-IN MIXERS FOR BATH AND SHOWER

Nuove opzioni di miscelatori a incasso si aggiungono ai modelli più tradizionali già disponibili nel catalogo generale Remer, aumentando le prestazioni e la creatività progettuale per le aree del bagno dedicate a doccia e vasca.

*New built-in mixer options added to the more traditional models already available in the Remer general catalogue, increasing performance and design creativity in the areas dedicated to the shower and bathtub.*

### MISCELATORI A 2 VIE CON DEVIATORE CERAMICO - 2-WAY MIXER WITH CERAMIC DIVERTER

I modelli di miscelatore a incasso per vasca o doccia che includono 09H nel codice prodotto utilizzano un deviatore a 2 vie con vitone ceramico. Per selezionare l'uscita desiderata, la manopola del deviatore deve essere ruotata da una posizione all'altra.

*Built-in bath or shower mixers that include 09H in the product code use a 2-way diverter with ceramic head valve. To select the desired output, the diverter knob must be turned from one position to the other.*

Con piastra tonda <i>With round plate</i>	09H
Con piastra rettangolare verticale <i>With rectangular vertical plate</i>	09HG
Con piastra rettangolare orizzontale <i>With rectangular horizontal plate</i>	09HRG

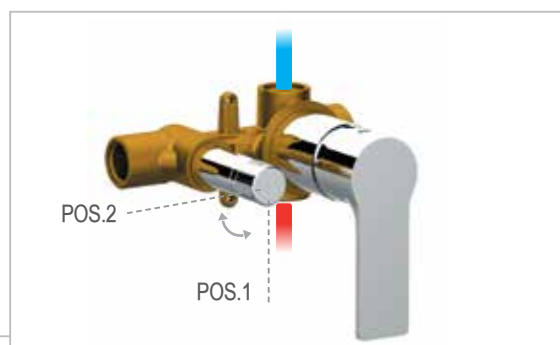

### MISCELATORI A 2 O 3 VIE CON DEVIATORE MECCANICO - 2 OR 3-WAY MIXERS WITH MECHANICAL DIVERTER

I modelli di miscelatore a incasso per vasca o doccia che includono 92Z o 93Z nel codice prodotto utilizzano un deviatore meccanico in linea orizzontale. A seconda del modello scelto, si possono gestire 2 oppure 3 uscite acqua. Per selezionare l'uscita desiderata, posizionare la manopola del deviatore sulla posizione corrispondente.

*Built-in bath or shower mixers that include 92Z or 93Z in the part number use a horizontally positioned mechanical diverter. Depending on the model chosen, 2 or 3 water outlets can be managed. To select the desired water outlet, turn the diverter knob to the corresponding position.*

Con piastra orizzontale - *With horizontal plate* 92Z / 93Z

Con piastre tonde separate - *With separate round plates* 92ZP / 93ZP

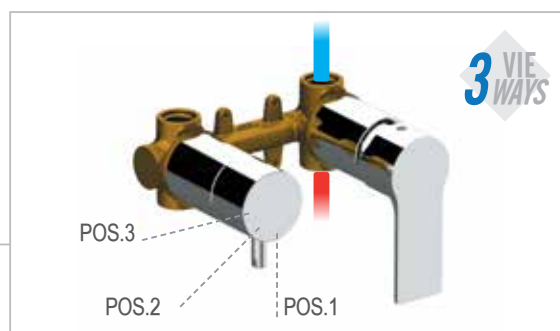
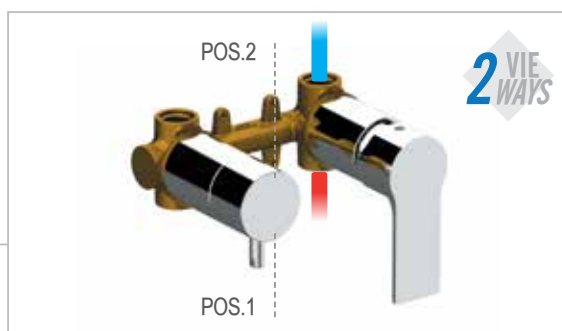

**MISCELATORI A 2 O 3 VIE CON DOCCETTA INTEGRATA - 2 OR 3-WAY MIXERS WITH HAND SHOWER**

Questi miscelatori a incasso per vasca o doccia utilizzano un deviatore meccanico a scelta tra 2 o 3 vie. La parte a incasso è un corpo unico che collega miscelatore, deviatore e la presa acqua del kit doccia. Da completare con una seconda uscita acqua (ed una terza uscita a seconda del modello): ad esempio soffione, getti o bocca a incasso.

*These built-in bath and shower mixers use a mechanical diverter for 2 or 3 outlets. The built-in part is a single block for mixer, diverter and the hand shower kit. To be completed with a second water outlet (and third one depending on model): E.g. shower head, body-jets or wall spout.*

Con piastra rettangolare - *With rectangular plate*

97D

Con piastre tonde separate - *With separate round plates*

97PD

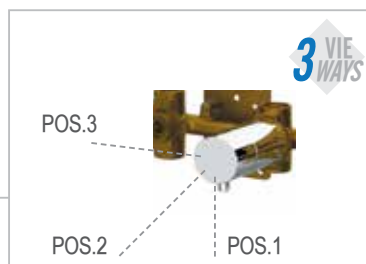
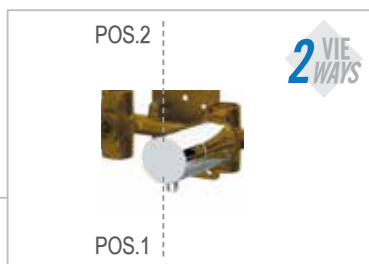

**MISCELATORI A 2 O 3 VIE CON BOCCA INTEGRATA - 2/3 WAY MIXERS WITH WALL SPOUT**

Questi miscelatori a incasso per vasca e doccia utilizzano un deviatore meccanico a scelta tra 2 o 3 vie. La parte a incasso è un corpo unico che collega miscelatore, deviatore e la bocca a muro. Da completare con una seconda uscita acqua (ed una terza uscita a seconda del modello): ad esempio soffione, getti o doccia.

*These built-in bath and shower mixers use a mechanical diverter for 2 or 3 outlets. The built-in part is a single block for mixer, diverter and the wall spout. To be completed with a second water outlet (and third one depending on model): E.g. shower head, body-jets or hand shower.*

Con piastra rettangolare - *With rectangular plate*

54D

Con piastre tonde separate - *With separate round plates*

54PD

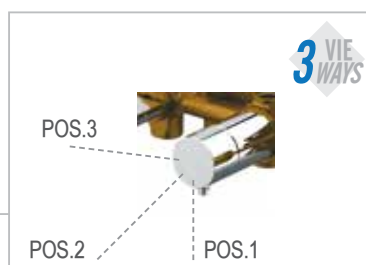
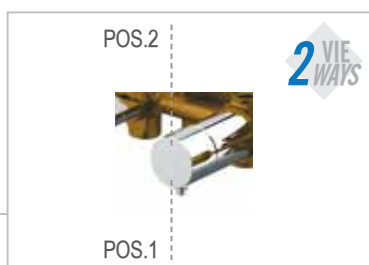

**MISCELATORI A 3, 4 O 5 VIE CON VITONE CERAMICO - 3, 4 OR 5-WAY MIXER WITH CERAMIC HEADVALVE**

I miscelatori a incasso per vasca o doccia che includono 98D nel codice prodotto permettono di gestire, a seconda del modello, da 3 a 5 uscite acqua tramite deviatori a vitone ceramico dedicati. Per azionare l'uscita desiderata, ruotare la manopola del deviatore corrispondente. Questi modelli prevedono un'unica parte a incasso e possono essere installati sia in orizzontale che in verticale.

*The built-in mixers for bath or shower that include 98D in the product code allow you to manage, depending on the model, from 3 to 5 water outlets via dedicated ceramic valve diverters. To activate the desired output, turn the knob of the corresponding outlet. These models have a single built-in part and can be installed both horizontally and vertically.*

Con piastra rettangolare  
*With rectangular plate*

98D

Con piastre tonde separate  
*With separate round plates*

98D

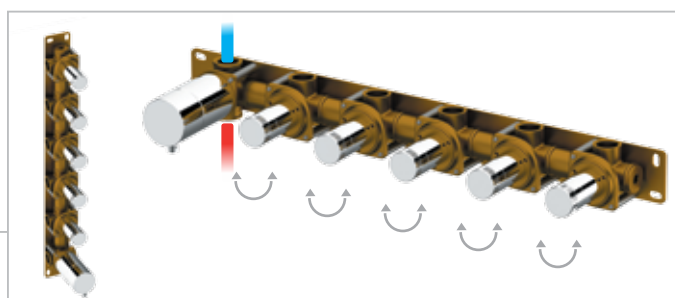

## MISCELATORI A 2 VIE CON DEVIATORE CERAMICO - 2-WAY MIXER WITH CERAMIC DIVERTER



CON PIASTRA TONDA  
WITH ROUND PLATE

Miscelatore a incasso per vasca o doccia con deviatore a 2 vie con vitone ceramico su piastra tonda. Per selezionare l'uscita desiderata, la manopola del deviatore deve essere ruotata da una posizione all'altra.

*Built-in mixer for bath or shower with 2-way diverter with ceramic head valve on round plate. To select the desired output, the diverter knob must be turned from one position to the other.*



### ELEMENT

**ET09H**  
2 vie 2-way



### SLASH

**SL09H**  
2 vie 2-way



### DOT

**DT09H**  
2 vie 2-way



### X-STYLE

**X09H**  
2 vie 2-way



### ENERGY

**EY09H**  
2 vie 2-way



### VANITY

**V09H**  
2 vie 2-way



### INFINITY

**I09H**  
2 vie 2-way



### DREAM

**D09H**  
2 vie 2-way



### CLASS LINE

**L09H**  
2 vie 2-way



### WINNER

**W09H**  
2 vie 2-way



## MISCELATORI A 2 VIE CON DEVIATORE CERAMICO - 2-WAY MIXER WITH CERAMIC DIVERTER



CON PIASTRA RETTANGOLARE VERTICALE  
WITH RECTANGULAR VERTICAL PLATE

Miscelatore a incasso per vasca o doccia con deviatore a 2 vie con vitone ceramico, su piastra rettangolare con montaggio verticale. Per selezionare l'uscita desiderata, la manopola del deviatore deve essere ruotata da una posizione all'altra.

*Built-in mixer for bath or shower with 2-way diverter with ceramic head valve, on rectangular plate with vertical mounting. To select the desired output, the diverter knob must be turned from one position to the other.*



## SLASH

**SL09HG**  
2 vie 2-way



## DOT

**DT09HG**  
2 vie 2-way



## Q DESIGN

**QD09HG**  
2 vie 2-way



## ABSOLUTE

**AU09HG**  
2 vie 2-way



## ENERGY

**EY09HG**  
2 vie 2-way



## VANITY

**V09HG**  
2 vie 2-way



## INFINITY

**I09HG**  
2 vie 2-way



## DREAM

**D09HG**  
2 vie 2-way



## CLASS LINE

**L09HG**  
2 vie 2-way



## WINNER

**W09HG**  
2 vie 2-way

## MISCELATORI A 2 VIE CON DEVIATORE CERAMICO - MISCELATORI A 2 VIE CON DEVIATORE CERAMICO



CON PIASTRA RETTANGOLARE ORIZZONTALE  
WITH RECTANGULAR HORIZONTAL PLATE

Miscelatore a incasso per vasca e doccia con deviatore a 2 vie con vitone ceramico, su piastra rettangolare con installazione orizzontale. Per selezionare l'uscita desiderata, la manopola del deviatore deve essere ruotata da una posizione all'altra.

*Built-in mixer for bath and shower with 2-way diverter with ceramic head valve, on rectangular plate with horizontal mounting. To select the desired output, the diverter knob must be turned from one position to the other.*

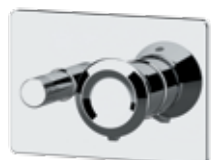

### ELEMENT

**ET09HRG**  
2 vie 2-way

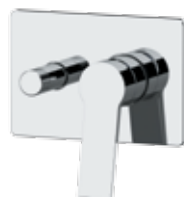

### SLASH

**SL09HRG**  
2 vie 2-way

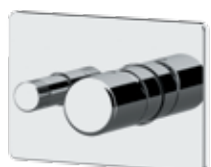

### DOT

**DT09HRG**  
2 vie 2-way



### X-STYLE

**X09HRG**  
2 vie 2-way



### Q DESIGN

**QD09HRG**  
2 vie 2-way



### ABSOLUTE

**AU09HRG**  
2 vie 2-way



### ENERGY

**EY09HRG**  
2 vie 2-way



### VANITY

**V09HRG**  
2 vie 2-way



### INFINITY

**I09HRG**  
2 vie 2-way



### DREAM

**D09HRG**  
2 vie 2-way



### CLASS LINE

**L09HRG**  
2 vie 2-way

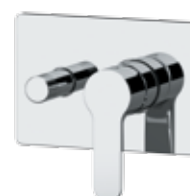

### WINNER

**W09HRG**  
2 vie 2-way



SLASH  
SL09HRGNO

## MISCELATORI A 2 O 3 VIE CON DEVIATORE MECCANICO - 2 OR 3-WAY MIXERS WITH MECHANICAL DIVERTER

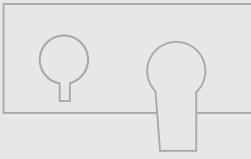

CON PIASTRA RETTANGOLARE  
WITH RECTANGULAR PLATE

Miscelatore a incasso per vasca e doccia con deviatore a 2 o 3 vie di tipo meccanico. Piastra rettangolare ultra piatta per installazione in orizzontale. Per selezionare l'uscita desiderata, posizionare la manopola del deviatore sulla posizione corrispondente.

*Built-in mixer for bath and shower with 2 or 3-way mechanical diverter.*

*Ultra flat rectangular plate for horizontal mounting.*

*To select the desired water outlet, turn the diverter knob to the corresponding position.*

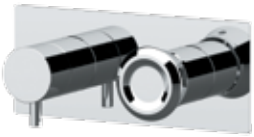

### ELEMENT

**ET92Z**  
2 vie 2-way

**ET93Z**  
3 vie 3-way

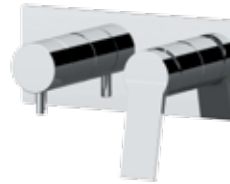

### SLASH

**SL92Z**  
2 vie 2-way

**SL93Z**  
3 vie 3-way

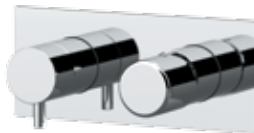

### DOT

**DT92Z**  
2 vie 2-way

**DT93Z**  
3 vie 3-way

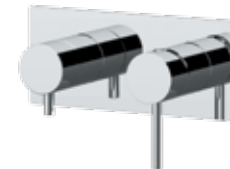

### X-STYLE

**X92Z**  
2 vie 2-way

**X93Z**  
3 vie 3-way

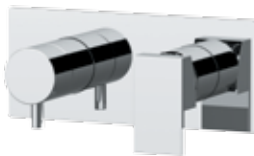

### Q DESIGN

**QD92Z**  
2 vie 2-way

**QD93Z**  
3 vie 3-way

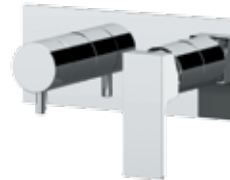

### ABSOLUTE

**AU92Z**  
2 vie 2-way

**AU93Z**  
3 vie 3-way

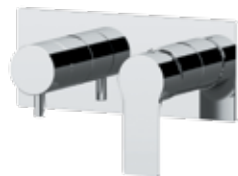

### ENERGY

**EY92Z**  
2 vie 2-way

**EY93Z**  
3 vie 3-way

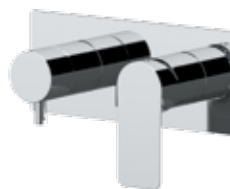

### INFINITY

**I92Z**  
2 vie 2-way

**I93Z**  
3 vie 3-way

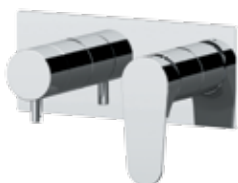

### CLASS LINE

**L92Z**  
2 vie 2-way

**L93Z**  
3 vie 3-way

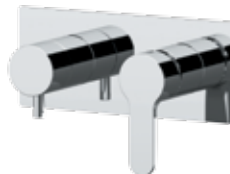

### WINNER

**W92Z**  
2 vie 2-way

**W93Z**  
3 vie 3-way



MISCELATORI A 2 O 3 VIE CON DEVIATORE MECCANICO - 2 OR 3-WAY MIXERS WITH MECHANICAL DIVERTER



CON PIASTRE TONDE SEPARATE  
WITH SEPARATE ROUND PLATES

Miscelatore a incasso per vasca o doccia con deviatore a 2 o 3 vie di tipo meccanico. Piastre tonde separate ultra piatte. Parte a incasso unica per installazione in orizzontale. Per selezionare l'uscita desiderata, posizionare la manopola del deviatore sulla posizione corrispondente.

*Built-in mixer for bath and shower with 2 or 3-way mechanical diverter. Separate ultra-flat round plates. Single built-in part for horizontal mounting. To select the desired water outlet, turn the diverter knob to the corresponding position.*

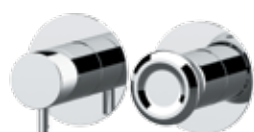

**ELEMENT**  
ET92ZP | ET93ZP  
2 vie 2-way | 3 vie 3-way



**SLASH**  
SL92ZP | SL93ZP  
2 vie 2-way | 3 vie 3-way

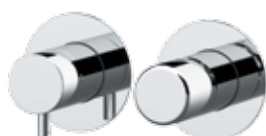

**DOT**  
DT92ZP | DT93ZP  
2 vie 2-way | 3 vie 3-way

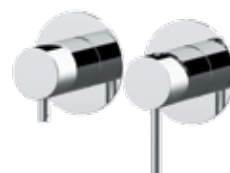

**X-STYLE**  
X92ZP | X93ZP  
2 vie 2-way | 3 vie 3-way



**ENERGY**  
EY92ZP | EY93ZP  
2 vie 2-way | 3 vie 3-way



**INFINITY**  
I92ZP | I93ZP  
2 vie 2-way | 3 vie 3-way



**CLASS LINE**  
L92ZP | L93ZP  
2 vie 2-way | 3 vie 3-way



**WINNER**  
W92ZP | W93ZP  
2 vie 2-way | 3 vie 3-way



ENERGY



ENERGY

## MISCELATORI A 2 O 3 VIE CON DOCCETTA INTEGRATA - 2 OR 3-WAY MIXERS WITH HAND SHOWER

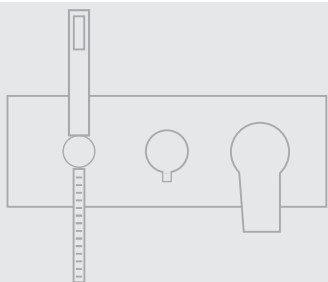

CON PIASTRA RETTANGOLARE  
WITH RECTANGULAR PLATE

Miscelatore a incasso per vasca e doccia con deviatore meccanico a 2 o 3 vie e kit doccia in ottone. Piastra rettangolare ultra piatta, parte a incasso unica.

Da completare con una seconda uscita acqua (ed una terza a seconda del modello).

*Built-in mixer for bath and shower with 2 or 3-way mechanical diverter and brass hand shower kit. Ultra flat rectangular plate, single built-in part.*

*To be completed with a second water outlet (and a third one depending on the model).*



### ELEMENT

**ET97D2**  
2 vie 2-way

**ET97D3**  
3 vie 3-way



### SLASH

**SL97D2**  
2 vie 2-way

**SL97D3**  
3 vie 3-way



### DOT

**DT97D2**  
2 vie 2-way

**DT97D3**  
3 vie 3-way



### X-STYLE

**X97D2**  
2 vie 2-way

**X97D3**  
3 vie 3-way



### Q DESIGN

**QD97D2**  
2 vie 2-way

**QD97D3**  
3 vie 3-way



### ABSOLUTE

**AU97D2**  
2 vie 2-way

**AU97D3**  
3 vie 3-way



### ENERGY

**EY97D2**  
2 vie 2-way

**EY97D3**  
3 vie 3-way



### INFINITY

**I97D2**  
2 vie 2-way

**I97D3**  
3 vie 3-way



### CLASS LINE

**L97D2**  
2 vie 2-way

**L97D3**  
3 vie 3-way



### WINNER

**W97D2**  
2 vie 2-way

**W97D3**  
3 vie 3-way



## MISCELATORI A 2 O 3 VIE CON DOCCETTA INTEGRATA - 2 OR 3-WAY MIXERS WITH HAND SHOWER

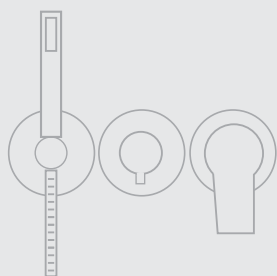

CON PIASTRE TONDE SEPARATE  
WITH SEPARATE ROUND PLATES

Miscelatore a incasso per vasca o doccia con deviatore meccanico a 2 o 3 vie e kit doccia in ottone. Piastre tonde separate ultra piatte, parte a incasso unica.

Da completare con una seconda uscita acqua (ed una terza a seconda del modello).

*Built-in mixer for bath or shower with 2 or 3-way mechanical diverter and brass hand shower kit. Separate ultra-flat round plates, single built-in part.*

*To be completed with a second water outlet (and a third one depending on the model).*



### ELEMENT

**ET97D2P**  
2 vie 2-way

**ET97D3P**  
3 vie 3-way



### SLASH

**SL97D2P**  
2 vie 2-way

**SL97D3P**  
3 vie 3-way



### DOT

**DT97D2P**  
2 vie 2-way

**DT97D3P**  
3 vie 3-way



### X-STYLE

**X97D2P**  
2 vie 2-way

**X97D3P**  
3 vie 3-way



### ENERGY

**EY97D2P**  
2 vie 2-way

**EY97D3P**  
3 vie 3-way



### INFINITY

**I97D2P**  
2 vie 2-way

**I97D3P**  
3 vie 3-way



### CLASS LINE

**L97D2P**  
2 vie 2-way

**L97D3P**  
3 vie 3-way



### WINNER

**W97D2P**  
2 vie 2-way

**W97D3P**  
3 vie 3-way

## MISCELATORI A 2 O 3 VIE CON BOCCA INTEGRATA - 2 OR 3-WAY MIXERS WITH WALL SPOUT



CON PIASTRA RETTANGOLARE  
WITH RECTANGULAR PLATE

Miscelatore a incasso per vasca e doccia con deviatore meccanico a 2 o 3 vie e bocca a muro. Piastra rettangolare ultra piatta, parte a incasso unica.

Da completare con una seconda uscita acqua (ed una terza a seconda del modello).

*Built-in mixer for bath and shower with 2 or 3-way mechanical diverter and wall spout.*

*Ultra flat rectangular plate, single built-in part.*

*To be completed with a second water outlet (and a third one depending on the model).*



### ELEMENT

**ET54D2**  
2 vie 2-way

**ET54D3**  
3 vie 3-way



### SLASH

**SL54D2**  
2 vie 2-way

**SL54D3**  
3 vie 3-way



### DOT

**DT54D2**  
2 vie 2-way

**DT54D3**  
3 vie 3-way

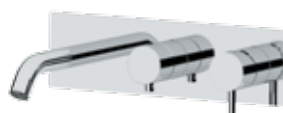

### X-STYLE

**X54D2**  
2 vie 2-way

**X54D3**  
3 vie 3-way



### Q DESIGN

**QD54D2**  
2 vie 2-way

**QD54D3**  
3 vie 3-way



### ABSOLUTE

**AU54D2**  
2 vie 2-way

**AU54D3**  
3 vie 3-way



### ENERGY

**EY54D2**  
2 vie 2-way

**EY54D3**  
3 vie 3-way

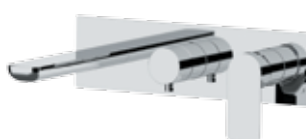

### INFINITY

**I54D2**  
2 vie 2-way

**I54D3**  
3 vie 3-way



### CLASS LINE

**L54D2**  
2 vie 2-way

**L54D3**  
3 vie 3-way



### WINNER

**W54D2**  
2 vie 2-way

**W54D3**  
3 vie 3-way

SET MISCELATORI A 2 VIE CON BOCCA INTEGRATA - 2-WAY MIXER SET WITH WALL SPOUT

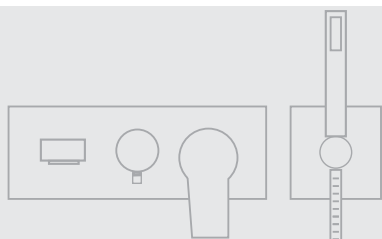

CON PIASTRA RETTANGOLARE E KIT DOCCIA  
WITH RECTANGULAR PLATE AND SHOWER KIT

Miscelatore a incasso per vasca e doccia con deviatore meccanico a 2 vie e kit doccia in ottone. Piastre ultrapiatte, parte a incasso unica per miscelatore, deviatore e bocca.

*Built-in mixer for bath or shower with 2 mechanical diverter and brass hand shower kit. Ultra-flat plates, single built-in part for mixer, diverter and spout.*



ELEMENT

ET53D2  
2 vie 2-way



SLASH

SL53D2  
2 vie 2-way



DOT

DT53D2  
2 vie 2-way



X-STYLE

X53D2  
2 vie 2-way



Q DESIGN

QD53D2  
2 vie 2-way



ABSOLUTE

AU53D2  
2 vie 2-way



ENERGY

EY53D2  
2 vie 2-way



INFINITY

I53D2  
2 vie 2-way



CLASS LINE

L53D2  
2 vie 2-way



WINNER

W53D2  
2 vie 2-way

## MISCELATORI A 2 O 3 VIE CON BOCCA INTEGRATA - 2 OR 3-WAY MIXERS WITH WALL SPOUT



CON PIASTRE TONDE SEPARATE  
WITH SEPARATE ROUND PLATES

Miscelatore a incasso per vasca e doccia con deviatore meccanico a 2 o 3 vie e bocca a muro. Piastre tonde separate ultra piatte, parte a incasso unica.

Da completare con una seconda uscita acqua (ed una terza a seconda del modello).

*Built-in mixer for bath and shower with 2 or 3-way mechanical diverter and wall spout.*

*Ultra flat separate round plates, single built-in part.*

*To be completed with a second water outlet (and a third one depending on the model).*



### ELEMENT

**ET54D2P**  
2 vie 2-way

**ET54D3P**  
3 vie 3-way



### SLASH

**SL54D2P**  
2 vie 2-way

**SL54D3P**  
3 vie 3-way



### DOT

**DT54D2P**  
2 vie 2-way

**DT54D3P**  
3 vie 3-way

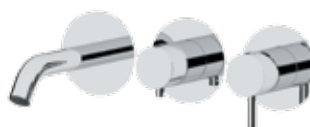

### X-STYLE

**X54D2P**  
2 vie 2-way

**X54D3P**  
3 vie 3-way



### ENERGY

**EY54D2P**  
2 vie 2-way

**EY54D3P**  
3 vie 3-way



### INFINITY

**I54D2P**  
2 vie 2-way

**I54D3P**  
3 vie 3-way



### CLASS LINE

**L54D2P**  
2 vie 2-way

**L54D3P**  
3 vie 3-way



### WINNER

**W54D2P**  
2 vie 2-way

**W54D3P**  
3 vie 3-way



SET MISCELATORI A 2 VIE CON BOCCA INTEGRATA - 2-WAY MIXER SET WITH WALL SPOUT

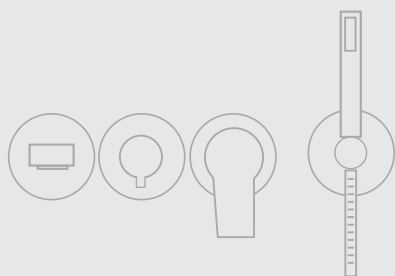

CON PIASTRE TONDE SEPARATE E KIT DOCCIA  
WITH SEPARATE ROUND PLATES AND SHOWER KIT

Miscelatore a incasso per vasca e doccia con deviatore meccanico a 2 vie e kit doccia in ottone. Piastre tonde ultrapiatte, parte a incasso unica per miscelatore, deviatore e bocca.

*Built-in mixer for bath or shower with 2 mechanical diverter and brass hand shower kit. Ultra-flat round plates, single built-in part for mixer, diverter and spout.*



ELEMENT

ET53D2P  
2 vie 2-way



SLASH

SL53D2P  
2 vie 2-way



DOT

DT53D2P  
2 vie 2-way



X-STYLE

X53D2P  
2 vie 2-way



ENERGY

EY53D2P  
2 vie 2-way



INFINITY

I53D2P  
2 vie 2-way



CLASS LINE

L53D2P  
2 vie 2-way



WINNER

W53D2P  
2 vie 2-way

## MISCELATORI A 3/4/5 VIE CON VITONE CERAMICO - 3, 4 OR 5-WAY MIXER WITH CERAMIC HEADVALVE

Miscelatore a incasso per vasca o doccia con deviatori singoli a vitone ceramico, da 3 a 5 uscite.

Per azionare l'uscita desiderata, ruotare la manopola del deviatore corrispondente. Parte a incasso unica, installazione possibile sia in orizzontale che in verticale.

*Built-in mixer for bath or shower with single ceramic valve diverters, from 3 to 5 outlets.*

*To open the desired water outlet, turn the knob of the corresponding diverter. Single recessed part, installation possible both horizontally and vertically.*

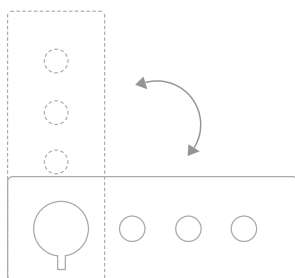

CON PIASTRA RETTANGOLARE  
WITH RECTANGULAR PLATE

**N98D3**  
3 vie 3-way



**N98D4**  
4 vie 4-way



**N98D5**  
5 vie 5-way

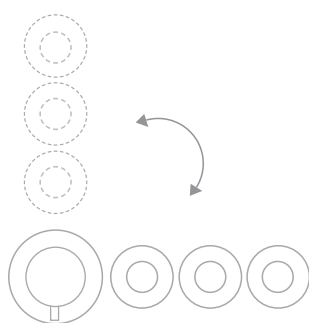

CON PIASTRE TONDE SEPARATE  
WITH SEPARATE ROUND PLATES

**N98D3P**  
3 vie 3-way



**N98D4P**  
4 vie 4-way



**N98D5P**  
5 vie 5-way





## SOFFIONI A SOFFITTO “EASY FIX” CON FARETTO LED “EASY FIX” CEILING SHOWER HEAD WITH LED POTLIGHT

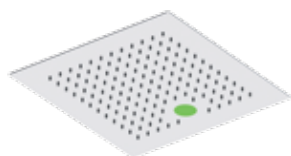

### 357REFS34

Soffione quadrato a soffitto 34x34 cm con getto a pioggia e faretto per cromoterapia, ispezionabile, acciaio INOX lucidato a specchio. Sistema di montaggio “Easy Fix”. Include pulsantiera a parete per comandi luce.  
*Square ceiling shower head, 34x34 cm, with rain jet and spotlight for colourtherapy, mirror polished stainless steel. “Easy Fix” mounting system. Wall push-button panel for light controls included.*

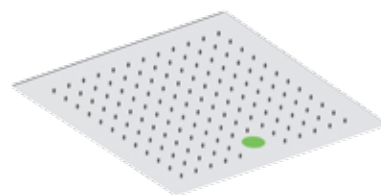

### 357REFS44

Soffione quadrato a soffitto 44x44 cm con getto a pioggia e faretto per cromoterapia, ispezionabile, acciaio INOX lucidato a specchio. Sistema di montaggio “Easy Fix”. Include pulsantiera a parete per comandi luce.  
*Square ceiling shower head, 44x44 cm, with rain jet and spotlight for colourtherapy, mirror polished stainless steel. “Easy Fix” mounting system. Wall push-button panel for light controls included.*

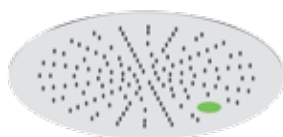

### 357REFM34

Soffione tondo a soffitto Ø34 cm con getto a pioggia e faretto per cromoterapia, ispezionabile, acciaio INOX lucidato a specchio. Sistema di montaggio “Easy Fix”. Include pulsantiera a parete per comandi luce.  
*Round ceiling shower head, Ø34 cm, with rain jet and spotlight for colourtherapy, mirror polished stainless steel. “Easy Fix” mounting system. Wall push-button panel for light controls included.*

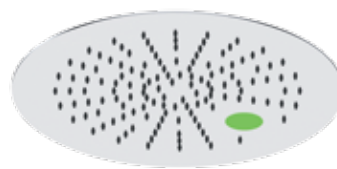

### 357REFM44

Soffione tondo a soffitto Ø44 cm con getto a pioggia e faretto per cromoterapia, ispezionabile, acciaio INOX lucidato a specchio. Sistema di montaggio “Easy Fix”. Include pulsantiera a parete per comandi luce.  
*Round ceiling shower head, Ø44 cm, with rain jet and spotlight for colourtherapy, mirror polished stainless steel. “Easy Fix” mounting system. Wall push-button panel for light controls included.*

2 VIE WAYS



### 357REFM44G

Soffione tondo a soffitto Ø44 cm con due uscite acqua: getto a pioggia e getto singolo centrale. Faretto per cromoterapia, ispezionabile, acciaio INOX lucidato a specchio. Sistema di montaggio “Easy Fix”. Include pulsantiera a parete per comandi luce.  
*Round ceiling shower head, Ø44 cm, with 2 water outlets: rain jet and central single jet. Spotlight for colourtherapy, mirror polished stainless steel. “Easy Fix” mounting system. Wall push-button panel for light controls included.*

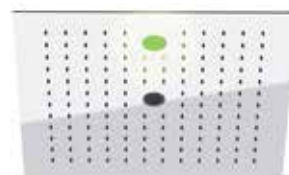

### 357REFS44G

Soffione quadrato a soffitto 44x44 cm con due uscite acqua: getto a pioggia e getto singolo centrale. Faretto per cromoterapia, ispezionabile, acciaio INOX lucidato a specchio. Sistema di montaggio “Easy Fix”. Include pulsantiera a parete per comandi luce.  
*Square ceiling shower head, 44x44 cm, with 2 water outlets: rain jet and central single jet. Spotlight for colourtherapy, mirror polished stainless steel. “Easy Fix” mounting system. Wall push-button panel for light controls included.*

PULSANTIERA CON INSTALLAZIONE A PARETE IN DOTAZIONE AL PRODOTTO:  
 WALL MOUNTING PUSH-BUTTON PANEL SUPPLIED WITH THE PRODUCT:

Gestione delle funzioni di cromoterapia:

- Prima pressione: ACCESO
- Pressioni successive: scelta manuale del colore
- Pressione prolungata (2 secondi): rotazione automatica dei colori
- 2 pressioni consecutive: SPENTO
- Sequenza colori LED RGB:
- Bianco - Rosso - Verde - Blu - Giallo - Fucsia – Azzurro

Colour therapy functions control:

- First button press: POWER ON
- Subsequent button presses: manual colour selection
- Long press (2 seconds): automatic colour rotation
- 2 consecutive button presses: POWER OFF
- RGB LED Colour sequence:
- White - Red - Green - Blue - Yellow - Fuchsia - Bright Blue



357REFM44G



2 VIE  
WAYS



2 VIE  
WAYS

### 357EFM34G

Soffione tondo a soffitto Ø34 cm con due uscite acqua: getto a pioggia e getto singolo centrale. Ispezionabile. Acciaio INOX lucidato a specchio. Sistema di montaggio "Easy Fix".

Round ceiling shower head, Ø34 cm, with 2 water outlets: rain jet and central single jet. Mirror polished stainless steel. "Easy Fix" mounting system.

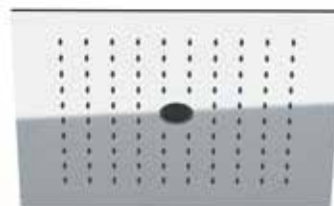

2 VIE  
WAYS

### 357EFS34G

Soffione quadrato a soffitto 34x34 cm con due uscite acqua: getto a pioggia e getto singolo centrale. Ispezionabile. Acciaio INOX lucidato a specchio. Sistema di montaggio "Easy Fix".

Square ceiling shower head, 34x34 cm, with 2 water outlets: rain jet and central single jet. Mirror polished stainless steel. "Easy Fix" mounting system.

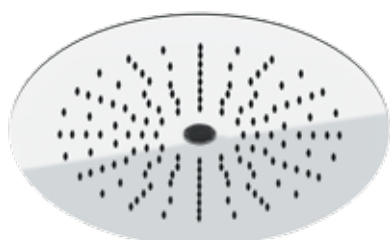

2 VIE  
WAYS

### 357EFM44G

Soffione tondo a soffitto Ø44 cm con due uscite acqua: getto a pioggia e getto singolo centrale. Ispezionabile. Acciaio INOX lucidato a specchio. Sistema di montaggio "Easy Fix".

Round ceiling shower head, Ø44 cm, with 2 water outlets: rain jet and central single jet. Mirror polished stainless steel. "Easy Fix" mounting system.

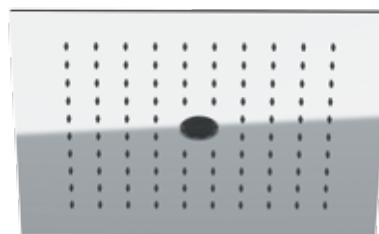

2 VIE  
WAYS

### 357EFS44G

Soffione quadrato a soffitto 44x44 cm con due uscite acqua: getto a pioggia e getto singolo centrale. Ispezionabile. Acciaio INOX lucidato a specchio. Sistema di montaggio "Easy Fix".

Square ceiling shower head, 44x44 cm, with 2 water outlets: rain jet and central single jet. Mirror polished stainless steel. "Easy Fix" mounting system.

## APPLICAZIONE A SOFFITTO "EASY FIX" - "EASY FIX" CEILING APPLICATION

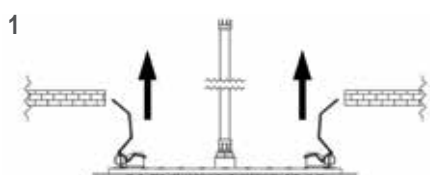

Per questa tipologia di soffione e con questo specifico sistema di fissaggio sono previste quattro molle per ogni soffione.

Nell'immagine 1 si evidenzia il primo movimento necessario:

caricare due molle vicine tra loro mettendole quasi in posizione verticale rispetto al soffione ed inserirle all'interno del foro precedentemente preparato. Rilasciare le stesse delicatamente.

*For this spec shower-head with this specific mounting system, four springs are installed on each head.*

*In picture 1, you shall see the first needed movement to activate them:*

*Spring-load two springs next to each other placing them almost vertically and insert them in the hole in the ceiling; Release them gently;*

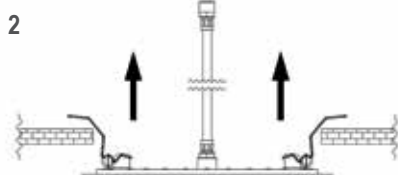

Mantenendo il soffione leggermente inclinato procedere caricando ed inserendo le rimanenti due molle come da immagine 2.

*While keeping the shower head slightly inclined, proceed by spring-loading and inserting the two other springs as shown in picture 2.*



A questo punto rilasciare delicatamente le molle alla loro naturale tensione e, trattenendo esternamente il soffione, accompagnare lo stesso verso il totale appoggio al soffitto come da immagine 3.

*Now release the springs back to their natural tension and, while holding the head from outside, guide it to its final position as shown in picture 3.*

---

**BODY JETS**

---

**AUX34JETB**

Body jet da incasso quadrato 8x8 cm, in acciaio INOX lucidato a specchio per sistema doccia, anticalcare.  
*Built-in squared body jet 8x8 cm, in stainless steel mirror polished for shower systems, antilimestone.*

**AUX34JETBN**

Body jet da incasso quadrato con getto nebulizzato, 8x8 cm, in acciaio INOX lucidato a specchio per sistema doccia, anticalcare.  
*Built-in squared nebulized body jet, 8x8 cm, in stainless steel mirror.*

---

**BOCCHIE A CASCATA  
WATERFALL SPOUTS**

---

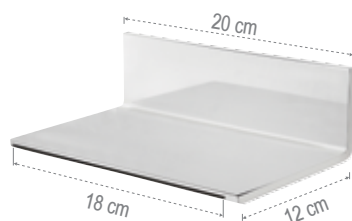
**359XL**

Bocca a parete a L con getto a cascata, in acciaio INOX lucidato a specchio.  
*L-shaped wall-mounting spout with waterfall jet, mirror polished stainless steel.*

**359XT**

Bocca rotonda a incasso con getto a cascata, in acciaio INOX lucidato a specchio.  
*Rounded built-in spout with waterfall jet, mirror polished stainless steel.*



## SHUT-OFF



### X65C25TW

Set per doccetta igienica shut-off comprensivo di miscelatore a incasso con leva minimale e presa acqua esterna, mensola portaoggetti integrata 100x210mm con supporto per doccetta, doccetta a pulsante in ottone, tubo flessibile 120cm.

*Set for body cleaning including built-in mixer with minimal lever and external water connection, 100x210mm shelf with hand shower holder, brass hand shower with shut-off system, 120cm flexible hose.*



### X65C25W

Set per doccetta igienica shut-off comprensivo di miscelatore a incasso con supporto doccia e presa acqua, doccetta in ottone con apertura a pulsante, tubo flessibile 120 cm. Cartuccia d.25.

*Set for body cleaning including, built-in mixer with shower holder and water intake, cylindrical brass hand shower with shut-off system, 120 cm flexible hose. Cartridge d.25.*



### X61PW

Set per doccetta igienica shut-off con cartuccia progressiva: apertura su acqua fredda e passaggio progressivo ad acqua calda tramite rotazione del supporto.

Il sistema di sicurezza integrato impedisce di aprire l'acqua quando la doccetta è inserita nel supporto e di riporre la doccetta prima di aver chiuso completamente la cartuccia. Set comprensivo di doccetta a pulsante in ottone e tubo flessibile cm 120. Cartuccia: d.25.

*Set for body cleaning with progressive cartridge: opening on cold water and progressive transition to hot water by rotating the support. The integrated safety system prevents both turning on the water when the hand shower is placed in its holder and putting the hand shower back in the holder before having completely turned off the water. Set including brass shut-off hand shower and 120 cm flexible hose. Cartridge: d.25.*



### X63REWMVA

Miscelatore incasso per shut-off su piastre separate, comprensivo di doccetta shut-off art. 332OW, supporto doccia-presa acqua con valvola di sicurezza e flessibile doccia cm 120.

NB: Le due parti a incasso sono indipendenti tra loro e permettono di posizionare i singoli elementi liberamente in base alle esigenze del progetto.

*Built-in shower mixer set on double flange, including shut-off art. 332OW, shower holder water punch with safety valve and shower flexible cm 120.*

*NB: The two built-in parts are independent of each other and allow the individual elements to be positioned freely according to each project needs.*

---

**OUTDOOR**

---



Colonna doccia da esterno in acciaio inox spazzolato, miscelatore monocomando a 2 vie con soffione tondo a pioggia anti-calcare e doccetta, acqua calda-fredda con attacco da pavimento.

*Outdoor shower column in brushed stainless steel, 2-way single lever mixer with anti-limestone round rain shower head and hand shower, hot-cold water with floor connection.*

**SS331Q2L7MMUFM20**

Con soffione doccia Ø20cm  
*With shower head Ø20cm*

**SS331Q2L7MMUFM25**

Con soffione doccia Ø25cm  
*With shower head Ø25cm*

**SS331Q2L7MMUFM30**

Con soffione doccia Ø30cm  
*With shower head Ø30cm*







SS331Q2L7MMUFM25

# NEWS CUCINA KITCHEN NEWS



ACQUA DEPURATA  
PURIFIED WATER

128

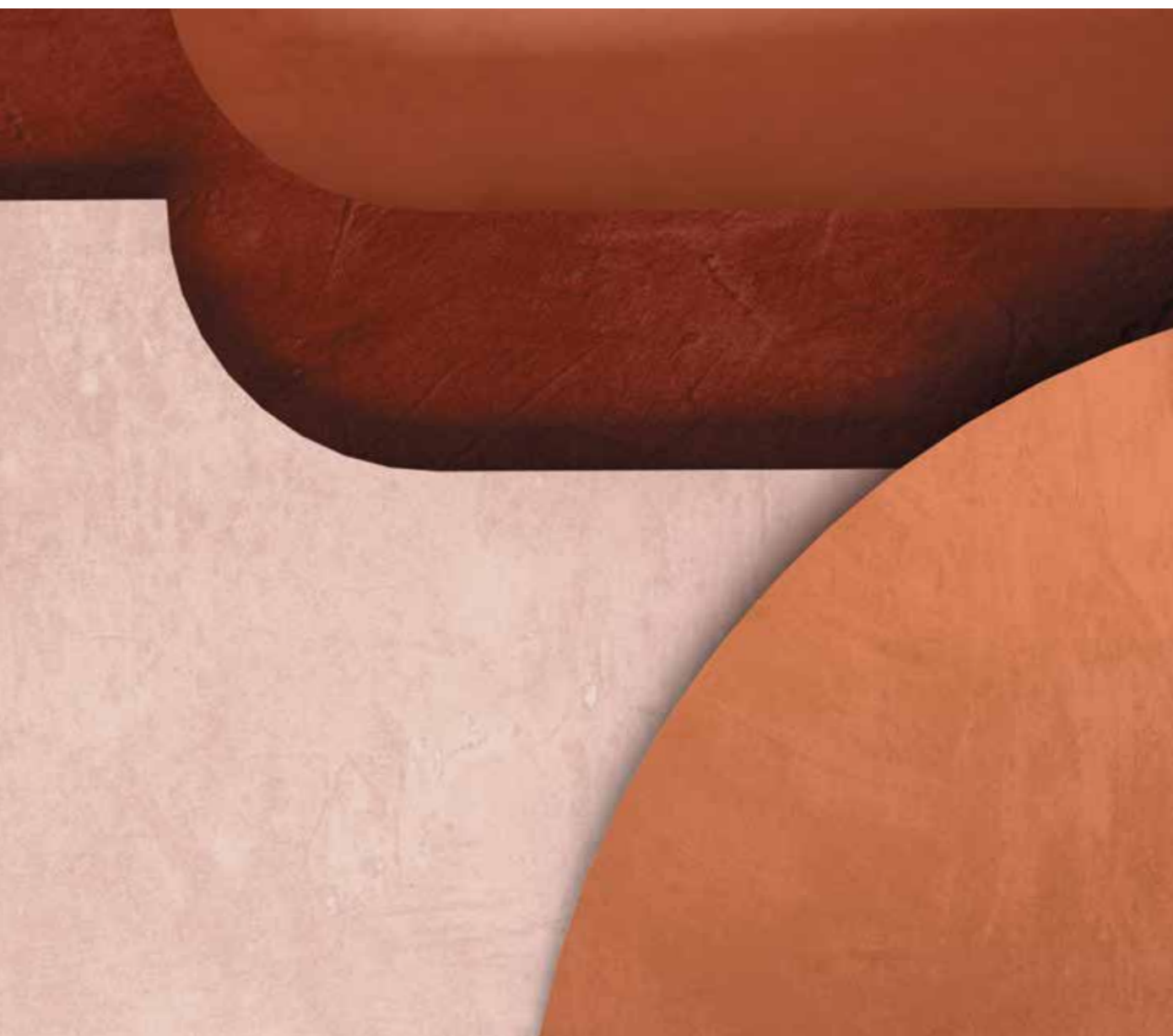



ACQUA CORRENTE MISCELATA  
*MIXED RUNNING WATER*



ACQUA DEPURATA  
*PURIFIED WATER*







Acqua depurata  
*Purified water*

Acqua corrente miscelata  
*Mixed running water*

Due canali di erogazione interni  
differenziati.  
*Two separated internal  
dispensing paths.*

Bocca girevole.  
*Swivel spout.*

Leva di miscelazione per la  
tradizionale gestione dell'acqua  
corrente calda e fredda.  
*Mixing lever for the traditional  
hot and cold running water  
management.*

Selettore acqua potabile.  
Ruotare di 90° in senso orario  
per erogare l'acqua depurata.  
*Drinking water selector.  
Turn 90° clockwise to dispense  
the purified water.*



## KIT ACQUA DEPURATA

Erogare l'acqua potabile filtrata direttamente dal rubinetto della cucina riduce drasticamente il consumo di bottiglie di plastica, i costi di trasporto e le conseguenti emissioni di CO<sub>2</sub>. Grazie alla collaborazione con BWT, nascono i KIT ACQUA DEPURATA: un'alternativa completa, sostenibile ed ecologica all'acqua in bottiglia.

Il miscelatore a 3 vie permette di accedere da un unico rubinetto sia all'acqua corrente che all'acqua depurata, mantenendo le due erogazioni separate per una totale sicurezza.

Il filtro BWT installato sotto il lavello rimuove dall'acqua corrente solidi e particelle sospese nonché odori e sapori indesiderati, per un'acqua buona, sana e a km zero.

I KIT ACQUA DEPURATA includono:

## PURIFIED WATER KIT

Filtered drinking water directly from the kitchen tap drastically reduces the consumption of plastic bottles, transport costs and the resulting CO<sub>2</sub> emissions. Thanks to the collaboration with BWT, the PURIFIED WATER KITS are available: a complete, sustainable and ecological alternative to bottled water.

The 3-way mixer allows access to both running water and purified water from a single tap, keeping the two outlets separated for total safety. The BWT filter installed under the sink removes solids and suspended particles from running water as well as unwanted smell and taste, for good, healthy and zero km water.

The PURIFIED WATER KITS include:



1

### MISCELATORE A 3-VIE PER LAVELLO

Miscelatore a 3-vie per lavello con leva di miscelazione per acqua corrente calda/fredda e selettore laterale per acqua depurata. Percorsi di erogazione separati, aeratori separati. Bocca girevole. Raccordi di collegamento inclusi.

#### 3-WAY MIXER FOR SINK

3-way sink mixer with mixing lever for hot / cold running water and side selector for purified water. Separate dispensing paths, separate aerators. Swivel mouth. Connection fittings included.

2

### MONITOR

Il monitor viene installato sotto il lavello e permette di verificare in ogni momento lo stato del filtro. Consiste in un'unità di conteggio programmabile e collegata al filtro tramite un sensore di flusso per indicarne la capacità in tempo reale. Il monitor avvisa tramite un segnale acustico, quando il filtro è in esaurimento e quando è necessario sostituirlo.

#### MONITOR

The monitor is installed under the sink and allows you to check the status of the filter at any time. It consists of a programmable counting unit connected to the filter via a flow sensor to indicate filter capacity in real time. The monitor also alerts you with an audible signal when the filter is low and when it needs to be replaced.

3

### FILTRO

Cartuccia filtrante BWT Bewapur HQ. Cartuccia a struttura composita in grado di trattenere impurità fino a 0,5 micron e rimuovere dall'acqua odori, sapori, colorazioni e corpi estranei non graditi. Il filtro viene installato direttamente sotto il lavandino, collegato sia alla rete idrica che al miscelatore. Capacità del filtro a 12° dH 6000 l.

#### FILTER

BWT filter cartridge with BWT Bewapur HQ drink filter. Composite structure cartridge to retain impurities up to 0.5 microns and remove unwanted smells, flavours, colours and foreign bodies from the water. The filter is installed under the sink, connected to both the water supply outlet and the mixer. Filter capacity at 12° dH 6000 l.

4

### TESTATA PORTA FILTRO

FILTER HOLDER

## Caratteristiche tecniche:

## Technical features:

Tipo di filtro - <i>Filter type</i>	Bewapur HQ S / Item code A890
Autonomia del filtro - <i>Filter life</i>	6000 litri - liter *
Finezza di filtrazione media - <i>Average filtration finenes</i>	0,5 micron
Portata nominale del filtro max. - <i>Max. nominal flow rate of the filter</i>	3,3 l/min
Dimensioni filtro + testata di connessione - <i>Filter size + connection head (H x D)</i>	270 x 100 mm

	FILTRI - FILTERS	RUBINETTO - TAP
Pressione di esercizio - <i>Operating pressure</i>	2 - 7 bar **	1 - 5 bar **
Temperatura consigliata ingresso acqua calda - <i>Recommended hot water inlet temperature</i>	-	60°C
Temperatura dell'acqua min. / max. - <i>Water temperature min. / max.</i>	4 - 30°C	4 - 80°C
Temperatura ambiente min. / max. - <i>Room temperature min. / max.</i>	4 - 40°C	4 - 40°C

\* L'autonomia del filtro può variare in funzione della qualità dell'acqua di alimento. Sostituire il filtro al raggiungimento dell'autonomia o al massimo dopo un anno.  
*The autonomy of the filter may vary depending on the quality of incoming water. Replace the filter upon reaching autonomy or at the latest after one year.*

\*\* Per pressioni superiori prevedere l'utilizzo di un riduttore di pressione.  
*For higher pressures, use a pressure reducer.*

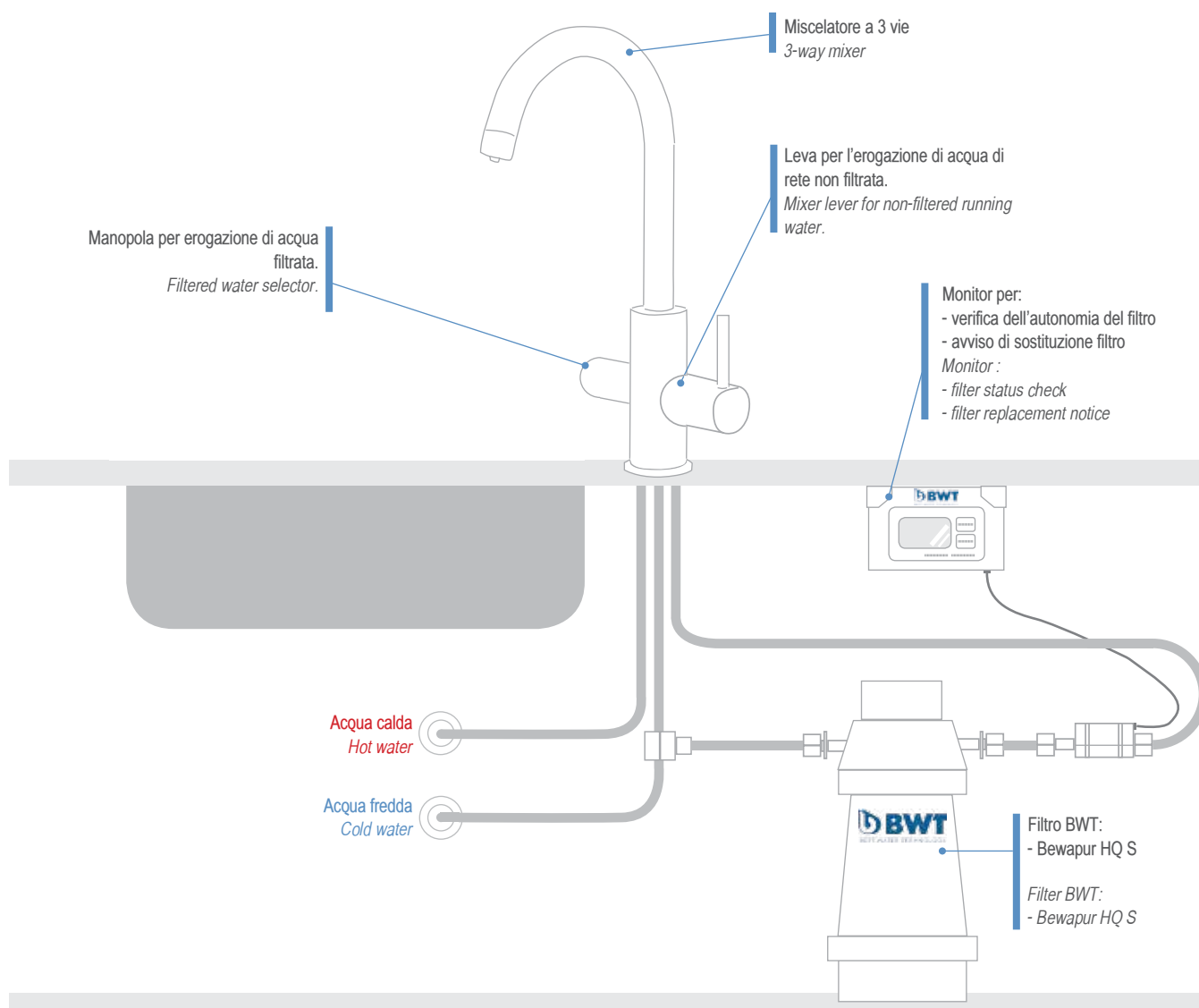



### N792DW70J

Kit completo per acqua depurata, include: miscelatore a 3-vie con selezione acqua potabile tramite leva laterale, monitor, testata e cartuccia filtrante F70J (BWT Bewapur HQ S).

*Complete kit for purified water, including: 3-way sink mixer with drinking water selection via side lever, monitor, head and F70J filter cartridge (BWT Bewapur HQ S).*



### EY79DW70J

Kit completo per acqua depurata, include: miscelatore a 3-vie con selezione acqua potabile tramite leva laterale, monitor, testata e cartuccia filtrante F70J (BWT Bewapur HQ S).

*Complete kit for purified water, including: 3-way sink mixer with drinking water selection via side lever, monitor, head and F70J filter cartridge (BWT Bewapur HQ S).*



### L79DW70J

Kit completo per acqua depurata, include: miscelatore a 3-vie con selezione acqua potabile tramite leva laterale, monitor, testata e cartuccia filtrante F70J (BWT Bewapur HQ S).

*Complete kit for purified water, including: 3-way sink mixer with drinking water selection via side lever, monitor, head and F70J filter cartridge (BWT Bewapur HQ S).*



### F70J

Cartuccia filtrante per ricambio BWT Bewapur HQ S, autonomia 6000 litri\*.  
*BWT Bewapur HQ S replacement filter cartridge, autonomy 6000 liters\*.*

\*L'autonomia del filtro può variare in funzione della qualità dell'acqua di alimento. Sostituire il filtro al raggiungimento dell'autonomia o al massimo dopo un anno.

*The autonomy of the filter may vary depending on the quality of incoming water. Replace the filter upon reaching autonomy or at the latest after one year.*





L79DW70J

## LEGENDA ICONE - *ICONS LEGEND*



Prodotto Novità  
New Product



Acciaio INOX  
Stainless Steel



Disponibile in finitura  
Finishings available



Perfect Tune:  
Prodotto disponibile  
in più varianti.  
Perfect Tune:  
Product available  
in different variants.

### RUBINETTERIA - *FAUCETS*



Con scarico  
With pop-up waste



Cartuccia Energy Saving  
Energy Saving Cartridge



Con scarico in plastica  
With plastic waste



Limitatore di Temperatura  
Antiscalding



Con Click-Clack  
With Click-Clak



Risparmio Idrico Dinamico  
Water Saving Dynamic



Con Click-Clack con Troppo Pieno  
With Click-Clak with Overflow



Risparmio Idrico  
Water Saving



Senza Scarico  
Without Waste



Risparmio Energetico  
Energy Saving



Eco  
Eco



Risparmio Idrico e Energetico  
Water and Energy Saving

### CUCINA - *KITCHEN*



Bocca Girevole  
Swivel Spout



Bocca Abbattibile  
Folding Spout



Corpo girevole  
Swivel body



Doccetta a due funzioni  
Two functions hand shower.



Doccetta Orientabile  
Adjustable handshower



Acqua Frizzante  
Sparkling Water



Doccetta Estraibile  
Pull-Out Handshower



Acqua Potabile  
Drinking Water

### TECNOLOGIA - *TECHNOLOGY*



Touch-Me  
Touch-Me



Azionamento a Sensore  
Sensor Control



Tempor Touch  
Tempor Touch



Con Temporizzazione per Lavatrice/Lavastoviglie  
With Timing for washing/machine and Dish/Washer



Con Luce Led  
Whit Led Light



Con filtro incluso  
With filter included



Con Batterie Alcaline Include  
With Alkaline Batteries included



Con Batterie al Litio Include  
With Lithium Batteries included











Alimentazione Elettrica  
Power Supply



Termostatico  
Thermostatic



**SOFFIONI - SHOWER HEADS**

-  Getto effetto pioggia ad ampia copertura  
Wide coverage rain effect
-  Getto effetto pioggia a risparmio idrico  
Water-saving rain effect jet
-  Con Multigetto  
With Multi Jet
-  Con Getto a Cascata  
With Waterfall Jet
-  Getto Nebulizzato  
Nebulized Jet
-  Cromoterapia  
Colortherapy
-  Autopulente  
Self-Cleaning
-  Con Getti Anticalcare  
With Antilimestone Jets

**KIT DOCCIA - SHOWER KIT**

-  2 Vie  
2 Ways
-  3 Vie  
3 Ways
-  4 Vie  
4 Ways
-  5 Vie  
5 Ways
-  Flessibile Lungo 120 cm  
Flexible Length 120 cm
-  Flessibile Lungo 150 cm  
Flexible Length 150 cm
-  Flessibile Lungo 200 cm  
Flexible Length 200 cm

**DOCCHETTE - HANDSHOWERS**

-  Posizione d'interruzione getto  
Stop flow position
-  Getto intenso esterno con getto effetto pioggia interno  
Intense external jet with internal rain effect jet
-  Getto intenso a risparmio idrico  
Intense water-saving jet
-  Massaggio vigoroso ampia copertura effetto pioggia  
Vigorous massage wide coverage rain jet
-  Getto vigoroso concentrato e getto esterno  
Concentrated vigorous jet and external jet
-  Getto vigoroso concentrato  
Vigorous concentrated jet
-  Getto Aerato Intenso  
Intense Aerated Jet
-  Getto vigoroso effetto pioggia  
Vigorous rain effect jet
-  Getto Vigoroso ed Ampio  
Vigorous and Wide Jet
-  Getto spray ampia copertura e getto intenso esterno a risparmio idrico  
Wide coverage spray jet and intense water saving external jet
-  Getto soft aerato mischiato ad un getto vigoroso a risparmio idrico  
Soft aerated jet mixed with a vigorous water-saving jet
-  Pioggia soft a risparmio idrico  
Soft rain water saving
-  Getto Esterno  
External Jet
-  Con Getti Anticalcare  
With Antilimestone Jets

**COLONNE DOCCIA - SHOWER COLUMNS**

-  Colonna Doccia Girevole  
Swivable shower column
-  Colonna Doccia Telescopica  
Telescopic shower column

**REMER**  
RUBINETTERIE



REMER RUBINETTERIE S.P.A.

Via Leonardo da Vinci, 83  
20062 Cassano d'Adda (MI) Italy  
Tel. +39 0363 364 211  
info@remer.eu www.remer.eu